

STRONGARM[®]

GAS CHARGED LIFT SUPPORTS

APPLICATION + BUYER'S GUIDE

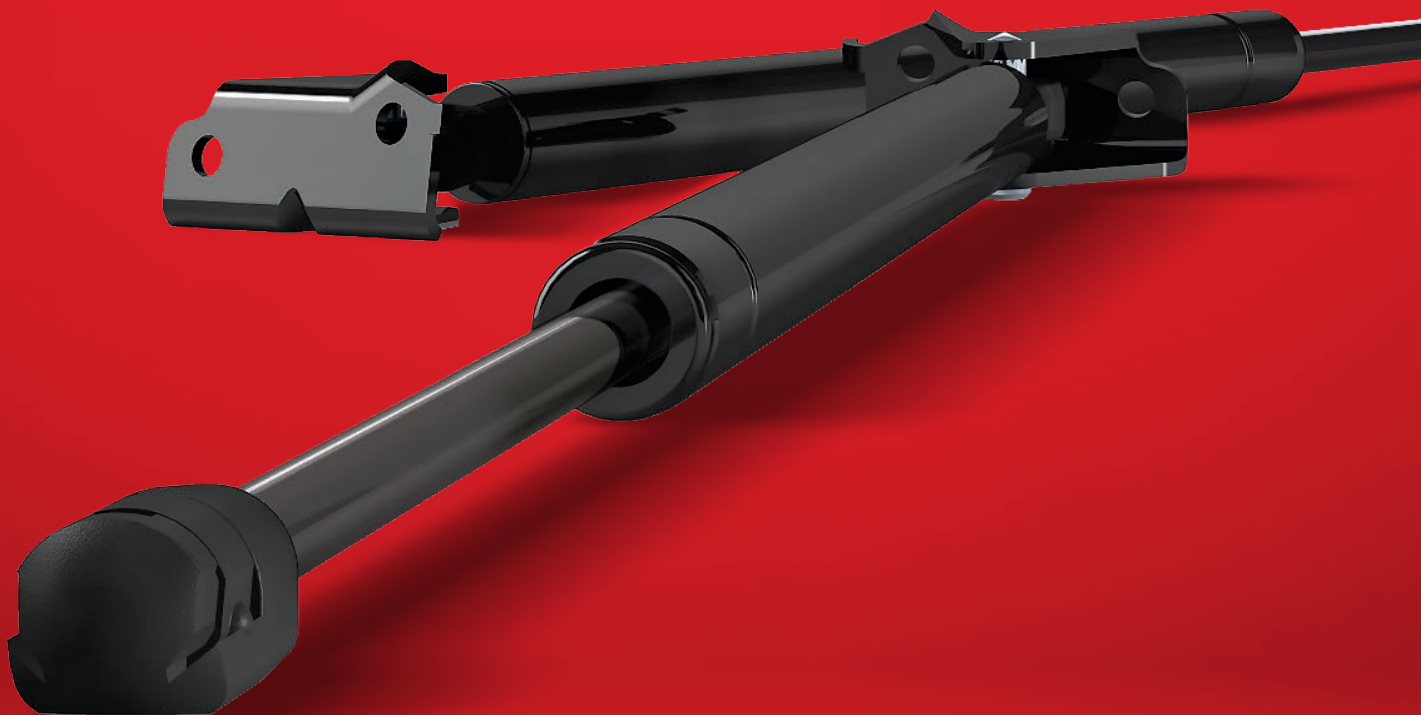

STRONGARM®

GAS CHARGED LIFT SUPPORTS



The Easy to Install Lift Support.

StrongArm® gas charged lift supports offer best-in-class coverage for everywhere your customer's vehicle needs a lift. Safe, secure and easy to install, StrongArm® delivers like new performance and reliability.

Engineered to Last

- ✓ Provides smoother operation
- ✓ Delivers longer lasting performance
- ✓ Direct fit, OEM replacement designs



StrongArm® Lift Support Features And Technologies:



- Rust Resistant Finish**
A quality rust resistant finish is applied to provide long lasting, corrosion free operation and appearance.
- Heavy Gauge Steel Body**
Electrostatically painted and heat cured to original equipment specification.
- Self-Cleaning Piston Assembly**
Provides smooth operation and more reliable performance.
- Rubber O-Ring Piston Seal**
Optimal hydraulic seal preventing fluid leakage around the piston for controlled lift and consistent performance.
- Specially Engineered Upper Bushing**
Manufactured with quality precision providing exact fit with piston rod and promotes longer operating life.
- Non-Stick Back-Up Ring**
Enhances performance through improved oil and gas pressure sealing.
- Hardened Nitride Plated Steel Shaft**
Provides optimal durability.



Engineered in US to OE quality standards for performance and durability



1 year limited warranty



IATF 16949, ISO 9001 certified; passes extensive quality checks and testing

TABLE OF CONTENTS

CONTENIDO TABLE DES MATIÈRES

Table of Contents / Contenido / Table des matières	1
Catalog Index / Índice del catálogo / Index du catalogue	(See Below) / (Vea abajo) / (Voir ci-dessous)
General Information / Información general / Informations générales	2
Installation Guide / Guía para instalación / Guide d'installation	3-6
Tailgate Assist Applications / Aplicaciones de asistencia con la compuerta trasera / Applications pour les assistances de hayon.....	7-8
Standard Applications / Aplicaciones estándar / Applications standard	9-55
Buyer's Guide / Guía del comprador / Guide de l'acheteur	56-77
Quick Tool Box Cross Reference / Referencia cruzada rápida para la caja de herramientas / Tableau de renvoi rapide pour la boîte à outils.....	78-79
Universal Coverage / Cobertura universal / Couverture universelle.....	80-86
Product Information / Información del Producto / Information produit.....	87

CATALOG INDEX – APPLICATIONS

ÍNDICE DEL CATÁLOGO – APLICACIONES INDEX DU CATALOGUE – APPLICATIONS

Acura.....	10	Lexus.....	35-36
American Motors.....	10	Lincoln.....	37
Audi.....	10-12	Maserati.....	37
BMW.....	12-18	Mazda.....	37-38
Buick.....	18-19	Mercedes-Benz.....	38-41
Cadillac.....	19-20	Mercury.....	41-42
Chevrolet.....	20-23	Merkur.....	42
Chrysler.....	23-24	Mini.....	42
Daewoo.....	24	Mitsubishi.....	42-43
Daihatsu.....	24	Nissan.....	43-44
DeLorean.....	24	Oldsmobile.....	45
Dodge.....	24-26	Peugeot.....	45
Eagle.....	26	Plymouth.....	45-46
Ferrari.....	26	Pontiac.....	46-47
Fiat.....	26	Porsche.....	47-48
Ford.....	26-29	RAM.....	48-49
Geo.....	29	Renault.....	49
GMC.....	29-30	Saab.....	49
Honda.....	30-31	Saturn.....	49-50
Hummer.....	31	Scion.....	50
Hyundai.....	31-32	Seat.....	50
Infiniti.....	32-33	Smart.....	50
International.....	33	Subaru.....	50
Isuzu.....	33	Suzuki.....	50-51
Jaguar.....	33-34	Toyota.....	51-53
Jeep.....	34	Volkswagen.....	53-54
Kia.....	35	Volvo.....	54-55
Land Rover.....	35	Yugo.....	55

GENERAL INFORMATION

INFORMACIÓN GENERAL / INFORMATIONS GÉNÉRALES

The Original and #1 Aftermarket Seller of Gas Charged Lift Supports

Gas charged lift supports are energy storage devices which create energy by compressing gas inside a cylinder. When closed, the energy is stored. When opened, the energy is released to raise hoods, trunks and hatches and hold them safely in an open position. To ensure safe and effective operation, the lift support must match the specific application. That's why StrongArm® custom engineers each support to a specific vehicle application and assures you of the right fit every time.

El vendedor original y el primero en ventas del mercado de repuestos para soportes elevadores a gas

Los soportes elevadores de gas son dispositivos que almacenan energía al comprimirse el gas en el interior de un cilindro. Cuando están cerrados, la energía permanece almacenada. Cuando se abren, la energía se libera y permite abrir capós, cajuelas y puertas traseras y mantenerlos en posición abierta con firmeza y seguridad. Para asegurar que la operación sea segura y eficaz, el soporte elevador debe ser apto para la tarea específica. Por ello, StrongArm® diseña cada soporte para cada aplicación particular, garantizándole una integración perfecta en cada oportunidad.

Le premier fournisseur des supports de soulèvement à gaz d'origine et de l'après-vente

Les supports élévateurs à gaz sont des dispositifs qui emmagasinent l'énergie en comprimant un gaz à l'intérieur d'un cylindre. Lorsque le support est comprimé, l'énergie s'y accumule. Lorsque le support est détendu, l'énergie est libérée afin de maintenir ouvert en toute sécurité un capot, un couvercle de coffre ou un haillon. Pour assurer un fonctionnement sécuritaire et efficace, les supports doivent être adaptés aux applications spécifiques. C'est pourquoi les ingénieurs de StrongArm® ont conçu des supports élévateurs en fonction des exigences et du type d'installation de votre véhicule.

We are adding new numbers and applications all the time. Please visit us at www.StrongArmLiftSupports.com if you don't find your application listed.

- Always replace both lift supports when applicable to assure top performance and prevent twisting caused by uneven loading.
- StrongArm® gas charged lift supports typically store a gas charge of over 1500 psi and cannot be compressed by hand.
- StrongArm® gas charged lift supports can be installed in minutes with no special tools required.
- Careful inspection of all hinges and lift support connecting points should be made for wear and tear or stress fractures and should be replaced or repaired before lift supports installation.
- Design of lift support is subject to change without notification.

Agregamos nuevos números y aplicaciones todo el tiempo. Si no encuentra su aplicación en esta lista, visítenos en www.StrongArmLiftSupports.com.

- Siempre cambie ambos soportes elevadores, si están instalados por pares, para asegurar un desempeño óptimo y evitar torceduras causadas por la carga desigual.
- Típicamente, los soportes elevadores de gas StrongArm® almacenan una carga de gas de más de 1500 psi y no pueden comprimirse manualmente.
- Los soportes elevadores de gas StrongArm® pueden instalarse en cuestión de minutos sin necesidad de herramientas especiales.
- Deben inspeccionarse todas las bisagras y puntos de conexión del soporte elevador para detectar posibles desgastes o fracturas por tensión, y deben cambiarse antes de instalar los soportes elevadores.
- El diseño del soporte elevador está sujeto a cambios sin previo aviso.

Nous ajoutons de nouvelles références et applications en permanence. Veuillez visiter le site www.StrongArmLiftSupports.com si vous ne trouvez pas l'application que vous recherchez.

- Toujours remplacer les deux supports élévateurs afin d'assurer un fonctionnement optimal et d'éviter les effets de torsion induits par une poussée inégale.
- Les supports élévateurs à gaz StrongArm® peuvent emmagasiner une pression d'environ 1500 lb/po2 et, de ce fait, ne sont pas compressibles à la main.
- Les supports élévateurs à gaz StrongArm® s'installent en quelques minutes et sans outils spéciaux.
- Il convient de vérifier attentivement les charnières et points de fixation des éléments au véhicule.
- Rechercher particulièrement des traces d'usure, de fatigue, des fractures ou des fissures. Toute anomalie doit être corrigée avant d'installer les nouveaux supports.
- La conception des supports peut changer sans préavis.

INSTALLATION GUIDE

GUÍA PARA INSTALACIÓN / GUIDE D'INSTALLATION

Installation Instructions

1. Turn off ignition. If old lift support has a window defogger electrical connector, carefully disconnect the fittings.
2. Before removing old lift supports, examine any hardware provided to determine which components must be reused.
3. Have someone hold the hatch, hood, trunk or rear window open while replacing the lift support.
DO NOT USE A PROP ROD.
4. Do not remove both lift supports at the same time. Replace one, then remove and replace the second one.
5. The new lift support must be installed in the same position as the old one which was removed, unless otherwise instructed. Do not nick or scratch chrome rod.
6. Compare the end connectors of your lift support to the illustrations provided and see additional instructions on the next page.

Instrucciones de instalación

1. Desconecte el encendido. Si el soporte elevador usado tiene un conector eléctrico para el desempañador de la ventana, desconéctelo con cuidado.
2. Antes de desmontar los soportes elevadores usados, revise los componentes para determinar cuáles deben reutilizarse.
3. Pida a alguien que mantenga abierta la puerta trasera, el capó, la cajuela o la ventana trasera mientras cambia el soporte elevador. **NO USE UNA VARILLA DE APOYO.**
4. No quite ambos soportes elevadores al mismo tiempo. Cambie primero uno y, después, desmonte y reemplace el segundo.
5. El nuevo soporte elevador debe instalarse en la misma posición que el usado, a menos que las instrucciones indiquen lo contrario. No marque ni raye el vástago cromado.
6. Compare los conectores terminales de su soporte elevador con las ilustraciones suministradas y consulte las instrucciones de la próxima página.

Directives d'installation

1. Couper le contact. Si l'ancien support élévateur est doté d'un connecteur électrique de lunette chauffante, débrancher le connecteur avec précaution.
2. Avant de retirer les fixations de l'ancien support élévateur, vérifier la quincaillerie fournie et déterminer celle qui sera réutilisée au montage.
3. Demander l'aide d'une personne pour maintenir le haillon, le capot ou le couvercle de coffre ouvert pendant le retrait des supports élévateurs. **NE PAS UTILISER DE TIGE OU DE BÉQUILLE.**
4. Ne pas retirer les deux supports élévateurs au même moment. Remplacer d'abord un des supports, puis remplacer l'autre support.
5. Sauf avis contraire, les nouveaux supports doivent être installés dans la même position que les anciens. Attention de ne pas endommager ou rayer la tige chromée du support.
6. Comparer les extrémités (points de fixation) de vos supports élévateurs aux illustrations fournies et consulter les instructions complémentaires.

INSTALLATION GUIDE

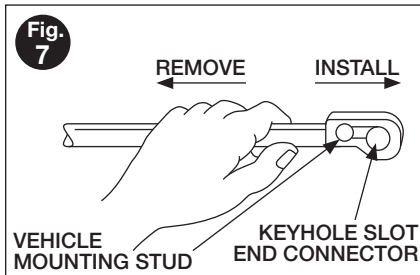
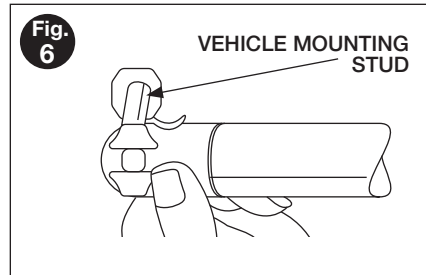
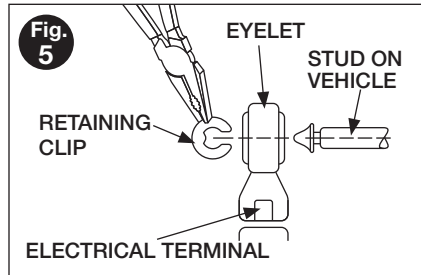
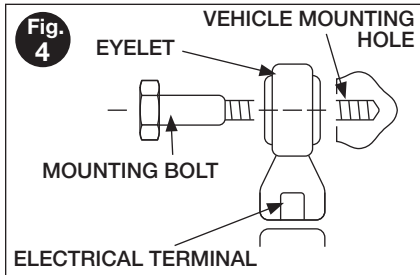
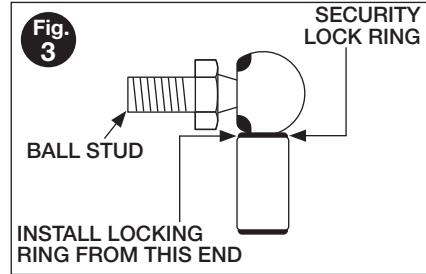
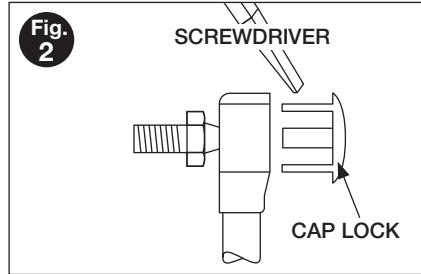
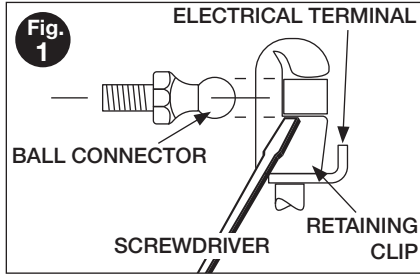

Removable Ball Connectors – Figures 1 2 3

- Remove old lift support by prying the retaining ring, cap lock or the security lock ring.
- Press new lift support onto ball stud and properly install retainer.

Eyelet Connector – Figures 4 5

- Remove old lift support by unscrewing the mounting bolt or removing the retaining clip. Install new lift support by reusing mounting bolt or retaining clip.
- Remove old lift support by prying the retaining clip off. Install new lift support by pressing against the vehicle mounting stud until the retaining clip snaps into place.

Eyelet Connector with Retaining Clip – Figure 6

- Remove old lift support by prying the retaining clip off.
- Install new lift support by pressing against the vehicle mounting stud until the retaining clip snaps into place.

Keyhole Slot Connector – Figure 7

- Slide the lift support so the keyhole slot can be lifted off the vehicle mounting stud.
- Install the new lift support by sliding the keyhole slot over the vehicle mounting stud.

GUÍA PARA INSTALACIÓN

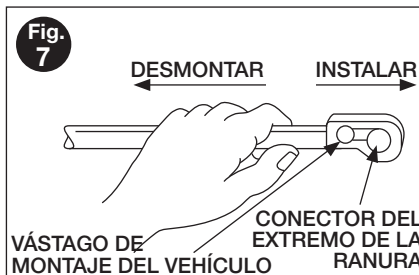
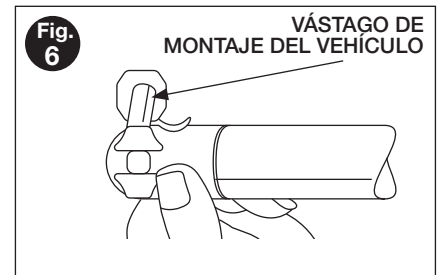
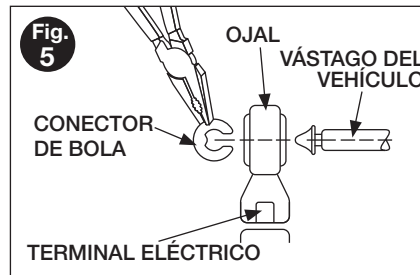
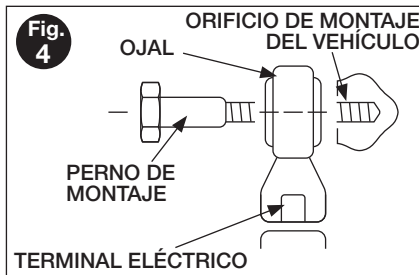
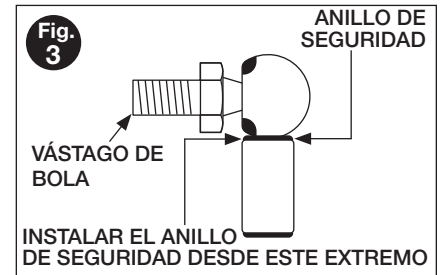
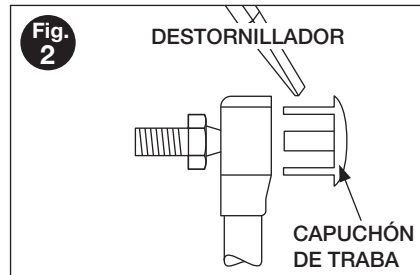
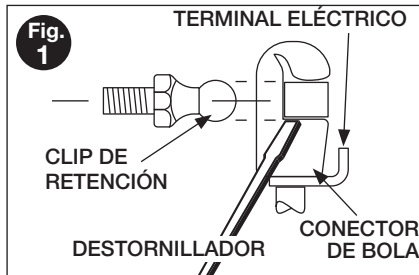

Conectores de bola desmontables – Figuras 1 2 3

- Quite el soporte elevador usado haciendo presión sobre el anillo de retención, el capuchón de traba o el anillo de seguridad.
- Presione el nuevo soporte elevador sobre el vástago de bola e instale el retenedor correctamente.

Conector de ojal – Figuras 4 5

- Retire el soporte elevador usado desatornillando el perno de montaje o quitando la abrazadera de retención. Instale el nuevo soporte elevador reutilizando el perno de montaje o la abrazadera de retención.
- Quite el soporte elevador usado haciendo palanca en la abrazadera de retención para quitarla. Coloque el soporte elevador nuevo presionando contra el vástago de montaje del vehículo hasta que la abrazadera de retención entre a presión.

Conector de ojal con abrazadera de retención – Figura 6

- Quite el soporte elevador usado haciendo presión sobre la abrazadera de retención para quitarla.
- Coloque el soporte elevador nuevo presionando contra el vástago de montaje del vehículo hasta que la abrazadera de retención entre a presión.

Conector de ranura – Figura 7

- Deslice el soporte elevador de manera que la ranura pueda levantarse y quitarse del vástago de montaje del vehículo.
- Instale el nuevo soporte elevador deslizando la ranura sobre el vástago de montaje del vehículo.

GUIDE D'INSTALLATION

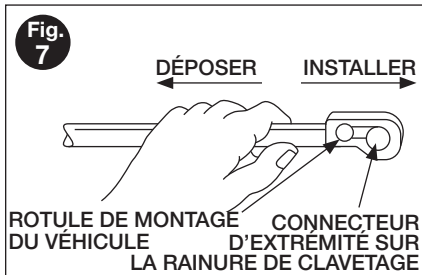
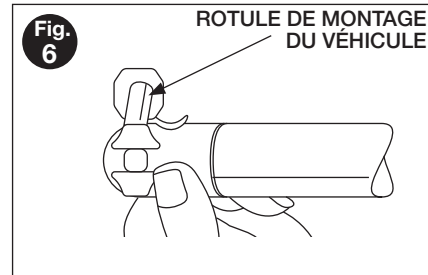
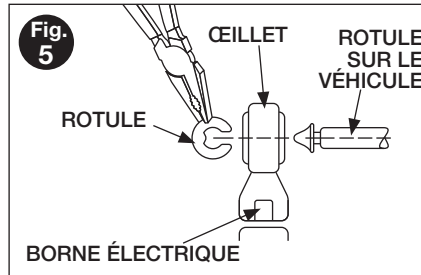
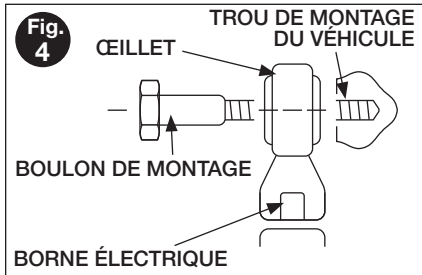
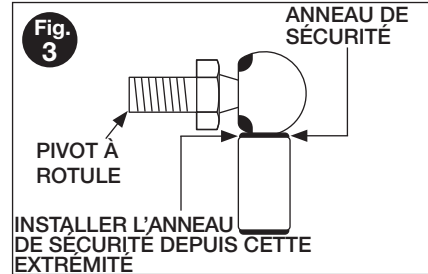
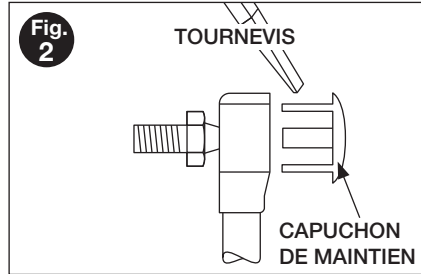
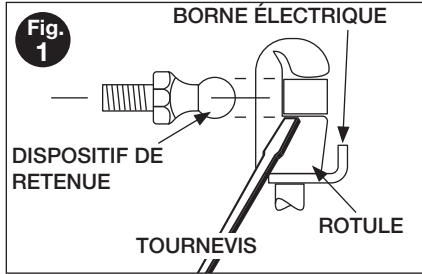

Montage par rotule démontable — Figures 1 2 3

- Retirer l'ancien support en écartant le dispositif de retenue (segment de retenue, capuchon de maintien ou anneau de sécurité).
- Engager le nouveau ressort sur la rotule et poser le dispositif de retenue.

Montage par oeillet — Figures 4 5

- Retirer l'ancien support en dévissant le boulon ou en retirant l'agrafe.
- Poser le nouveau support en réutilisant le boulon ou l'agrafe.

Montage par oeillet avec agrafe — Figure 6

- Retirer l'ancien support en écartant l'agrafe.
- Poser le nouveau support en appuyant à l'endroit de la rotule sur le véhicule jusqu'à l'engagement de l'agrafe.

Montage par rainure de clavetage — Figure 7

- Faire glisser le support de façon que la rainure de clavetage puisse être libérée de la rotule de montage sur le véhicule.
- Poser le nouveau support en glissant la rainure de clavetage sur la rotule de montage du véhicule.

TAILGATE ASSIST APPLICATIONS

APLICACIONES DE ASISTENCIA CON LA COMPUERTA TRASERA / APPLICATIONS POUR LES ASSISTANCES DE HAYON

MAKE & MODEL	LOCATION	YEAR	QTY	PART
Chevrolet				
Silverado 1500				
Aftermarket Upgrade	Tailgate	2007-18	1	GL2000
Aftermarket Upgrade	Tailgate	1999-06	1	GL2001
Silverado 1500 Classic				
Aftermarket Upgrade	Tailgate	2007	1	GL2001
Silverado 1500 HD				
Aftermarket Upgrade	Tailgate	2005-06	1	GL2001
Aftermarket Upgrade	Tailgate	2001-03	1	GL2001
Silverado 1500 HD Classic				
Aftermarket Upgrade	Tailgate	2007	1	GL2001
Silverado 2500				
Aftermarket Upgrade	Tailgate	1999-04	1	GL2001
Silverado 2500 HD				
Aftermarket Upgrade	Tailgate	2007-14	1	GL2000
Aftermarket Upgrade	Tailgate	2001-06	1	GL2001
Silverado 2500 HD Classic				
Aftermarket Upgrade	Tailgate	2007	1	GL2001
Silverado 3500				
Aftermarket Upgrade	Tailgate	2001-06	1	GL2000
Silverado 3500 Classic				
Aftermarket Upgrade	Tailgate	2007	1	GL2001
Silverado 3500 HD				
Aftermarket Upgrade	Tailgate	2007-19	1	GL2000
Dodge				
Ram 1500				
Aftermarket Upgrade	Tailgate	2002-09	1	GL2002
Ram 2500				
Aftermarket Upgrade	Tailgate	2002-09	1	GL2002
Ram 3500				
Aftermarket Upgrade	Tailgate	2002-09	1	GL2002
Ford				
F-150				
Aftermarket Upgrade	Tailgate	2015-21	1	GL2008
Aftermarket Upgrade	Tailgate	2004-14	1	GL2003
Aftermarket Upgrade	Tailgate	1997-03	1	GL2004
F-150 Heritage				
Aftermarket Upgrade	Tailgate	2004	1	GL2003
F-250 Super Duty				
Aftermarket Upgrade	Tailgate	2017-21	1	GL2009
Aftermarket Upgrade	Tailgate	2008-16	1	GL2005
Aftermarket Upgrade	Tailgate	1999-07	1	GL2004
F-350 Super Duty				
Aftermarket Upgrade	Tailgate	2017-21	1	GL2009
Aftermarket Upgrade	Tailgate	2008-16	1	GL2005
Aftermarket Upgrade	Tailgate	1999-07	1	GL2004
F-450 Super Duty				
Aftermarket Upgrade	Tailgate	2017-21	1	GL2009
GMC				
Sierra 1500				
Aftermarket Upgrade	Tailgate	2007-18	1	GL2000

MAKE & MODEL	LOCATION	YEAR	QTY	PART
GMC (cont.)				
Sierra 1500 (cont.)				
Aftermarket Upgrade	Tailgate	1999-06	1	GL2001
Sierra 1500 Classic				
Aftermarket Upgrade	Tailgate	2007	1	GL2001
Sierra 1500 HD				
Aftermarket Upgrade	Tailgate	2005-06	1	GL2001
Aftermarket Upgrade	Tailgate	2001-03	1	GL2001
Sierra 1500 HD Classic				
Aftermarket Upgrade	Tailgate	2007	1	GL2001
Sierra 2500				
Aftermarket Upgrade	Tailgate	1999-04	1	GL2001
Sierra 2500 HD				
Aftermarket Upgrade	Tailgate	2007-19	1	GL2000
Aftermarket Upgrade	Tailgate	2001-06	1	GL2001
Sierra 2500 HD Classic				
Aftermarket Upgrade	Tailgate	2007	1	GL2001
Sierra 3500				
Aftermarket Upgrade	Tailgate	2001-06	1	GL2000
Sierra 3500 Classic				
Aftermarket Upgrade	Tailgate	2007	1	GL2001
Sierra 3500 HD				
Aftermarket Upgrade	Tailgate	2007-19	1	GL2000
Lincoln				
Mark LT				
Aftermarket Upgrade	Tailgate	2006-08	1	GL2003
Nissan				
Frontier				
Aftermarket Upgrade	Tailgate	2005-15	1	GL2006
Toyota				
Tacoma				
Aftermarket Upgrade	Tailgate	2005-15	1	GL2007

GAS CHARGED LIFT SUPPORTS ARE DESIGNED TO BE USED EXCLUSIVELY FOR THE PURPOSE SPECIFIED IN APPLICATION CHARTS.

Tech Support 1-888-565-9632

STANDARD APPLICATIONS
APLICACIONES ESTÁNDAR / APPLICATIONS STANDARD

MAKE & MODEL	LOCATION	YEAR	QTY	PART
Acura				
CL				
	Hood	2001-03	2	E6322
	Hood	1997-99	2	D4656
Integra				
	Hatch	1994-01	2	A4979
	Hatch	1990-93	2	A4968
	Hatch	1986-89	2	A4808
Legend				
	Hood	1991-95	2	C4306
	Hood	1986-90	2	D4813
MDX				
	Hood	2014-16	1	D7173
	Hatch	2007-13	2	C6513
	Hood	2007-13	2	C6339
	Hatch	2001-06	2	C4561
	Hood	2001-06	2	C6332
RDX				
with Power Lift Gate	Liftgate, Gas Charged	2013-17	2	C7050
	Hatch	2007-12	2	C6660
RL				
	Hood	1996-01	2	D4146
RSX				
	Hatch	2002-04	2	D6145
TL				
	Hood	2009-14	2	E6826
	Hood	2004-08	2	E6351
	Hood	2002-03	2	E4160
	Hood	1999-01	2	E6322
	Hood	1996-98	2	D4146
TLX				
	Hood	2015-20	1	C7155
American Motors				
AMX				
with 10.39 (in) Compressed Length	Hatch	1978-80	2	D4401
with 20.25 (in) Compressed Length	Hatch	1978-80	2	A4902
Concord				
Wagon; 4-Door	Hatch	1978-83	2	D4403
Hatchback	Hatch	1978-79	2	A4902
Sedan	Hatch	1978-79	2	A4902
Eagle				
Wagon; 4-Door; Base	Hatch	1981-88	2	D4403
Wagon; 4-Door; Limited	Hatch	1980-87	2	D4403
Hatchback; 2-Door; DL SX4; without Spoiler	Hatch	1981-83	2	D4403
SX4; with Spoiler	Hatch	1981-83	2	D4401
Gremlin				
	Hatch	1978	2	D4430

MAKE & MODEL	LOCATION	YEAR	QTY	PART
American Motors (cont.)				
Hornet				
Wagon; 4-Door; Sportabout	Tailgate	1977	2	D4408
Hatchback	Hatch	1973-77	2	A4902
Pacer				
Wagon	Hatch	1977-80	2	D4401
Hatchback	Hatch	1975-80	2	D4402
Spirit				
	Hatch	1979-83	2	D4430
Audi				
100				
Wagon; 4-Door; C4 Body; S	Hatch	1994	2	C6369
	Hood	1992-94	2	A7149
Sedan; 4-Door	Trunk Lid	1992-94	2	D6426
	Hood	1989-91	2	D4621
100 Quattro				
	Hood	1992-94	2	A7149
Sedan; 4-Door	Trunk Lid	1992-94	2	D6426
	Hood	1989-91	2	D4621
200				
	Hood	1989-91	2	D4621
200 Quattro				
	Hood	1989-91	2	D4621
5000				
	Hatch	1987-88	2	C4880
From Serial # FN115151	Hood	1986-88	2	D4621
To Serial # FN115150	Hood	1984-86	2	B4743
	Hood	1978-83	1	A4850
5000 Quattro				
	Hood	1986-88	2	D4621
80				
B3 Body; with Spoiler	Trunk Lid	1988-92	2	E6534
80 Quattro				
B3 Body; with Spoiler	Trunk Lid	1988-92	2	E6534
90				
B4 Body; with Spoiler	Trunk Lid	1993-95	2	E6534
without Spoiler	Trunk Lid	1993-95	2	E6284
B3 Body; with Spoiler	Trunk Lid	1988-91	2	E6534
90 Quattro				
B4 Body; with Spoiler	Trunk Lid	1993-95	2	E6534
without Spoiler	Trunk Lid	1993-95	2	E6284
with Spoiler	Trunk Lid	1988-92	2	F6565
A3				
	Hatch	2006-13	2	C6007
	Hood	2006-13	1	B6000
A3 Quattro				
	Hatch	2006-13	2	C6007
	Hood	2006-13	1	B6000
A4				
Sedan; 4-Door	Hood	2009-16	1	B7150

GAS CHARGED LIFT SUPPORTS ARE DESIGNED TO BE USED EXCLUSIVELY FOR THE PURPOSE SPECIFIED IN APPLICATION CHARTS.

Tech Support 1-888-565-9632

APPLICATION GUIDE / GUÍA DE APLICACIONES / GUIDE D'APPLICATIONS



MAKE & MODEL	LOCATION	YEAR	QTY	PART
Audi (cont.)				
A4 (cont.)				
Sedan; 4-Door	Trunk Lid	2009-16	1	E7060
Convertible	Hood	2009	2	B6444
Cabriolet	Trunk Lid	2003-09	2	E6292
	Hood	2007-08	1	B6444
Base; with Spoiler	Trunk Lid	2004-06	2	E6282
Base	Hood	2003-06	1	B6444
Cabriolet	Hood	2003-06	1	C7121
Wagon; 4-Door; CAN; Avant	Hatch	2004-05	2	D6291
	Hood	2002	1	B6444
	Hood	1996-01	1	B6316
Sedan; 4-Door	Trunk Lid	1996-01	2	E4117
A4 allroad				
Wagon; 4-Door	Hood	2013-16	1	B7150
A4 Quattro				
Sedan; 4-Door	Hood	2009-16	1	B7150
Sedan; 4-Door	Trunk Lid	2009-16	1	E7060
Wagon; 4-Door	Hood	2009-12	1	B7150
Convertible	Hood	2009	2	B6444
with Spoiler	Trunk Lid	2006-09	2	E6282
	Hood	2007-08	2	B6444
Wagon; 4-Door; Avant	Hatch	2002-07	2	D6291
Cabriolet	Hood	2004-06	1	C7121
Avant	Hood	2003-06	2	B6444
Base	Hood	2003-06	2	B6444
	Hood	2002	2	B6444
Wagon; 4-Door; B5 Body; Avant	Hatch	1999-01	2	D6526
	Hood	1996-01	1	B6316
Sedan; 4-Door	Trunk Lid	1996-01	2	E4117
A5				
Coupe; 2-Door	Hood	2012-16	1	B7150
Hatchback; 4-Door	Hood	2011-16	1	B7150
Convertible; 2-Door	Hood	2010-14	1	B7150
Convertible	Trunk Lid	2010-14	2	E7144
Coupe; 2-Door	Hood	2009-10	1	B7150
A5 Quattro				
Convertible; 2-Door	Hood	2010-17	1	B7150
Convertible	Trunk Lid	2010-17	2	E7144
Coupe; 2-Door	Hood	2009-17	1	B7150
Coupe	Trunk Lid	2008-16	1	E7058
Hatchback; 4-Door	Hood	2014-15	1	B7150
A6				
	Trunk Lid	2012-18	1	D7059
	Hood	2011-18	2	E7159
with Spoiler	Hood	2005-10	1	B6569
with Spoiler	Trunk Lid	2006-09	2	E6282

MAKE & MODEL	LOCATION	YEAR	QTY	PART
Audi (cont.)				
A6 (cont.)				
without Spoiler	Trunk Lid	2005-06	2	F6570
	Trunk Lid	1999-04	2	E6622
	Hood	1998-04	1	B4989
Sedan; 4-Door	Trunk Lid	1995-98	2	D6426
Wagon; 4-Door; C4 Body; Avant	Hatch	1995-97	2	C6369
	Hood	1995-97	1	A6340
A6 Quattro				
	Trunk Lid	2012-18	1	D7059
	Hood	2011-18	2	E7159
with Spoiler	Hood	2005-10	1	B6569
with Spoiler	Trunk Lid	2006-08	2	E6282
without Spoiler	Trunk Lid	2005-06	2	F6570
Wagon; 4-Door	Hatch	2001-04	2	D6367
	Trunk Lid	1999-04	2	E6622
	Hood	1998-04	1	B4989
Wagon; 4-Door; with Special Window Glass	Hatch	1999-00	2	D6367
Wagon; 4-Door; without Special Window Glass	Hatch	1999-00	2	D6620
Sedan; 4-Door	Trunk Lid	1995-98	2	D6426
	Hood	1995-97	1	A6340
A7				
	Hood	2016-17	2	E7159
A7 Quattro				
	Hood	2012-18	2	E7159
A8				
	Hood	1997-99	2	D6354
A8 Quattro				
	Hood	2004-13	2	E6294
with Power Trunk	Trunk Lid	2004-10	2	E6571
	Hood	1997-03	2	D6354
	Trunk Lid	1997-03	2	D6431
allroad				
Wagon; 4-Door	Hood	2013-16	1	B7150
Allroad Quattro				
	Hood	2001-05	1	B4989
Wagon; 4-Door; New Design	Tailgate	2001-05	2	D6527
Wagon; 4-Door; Old Design	Tailgate	2001-05	1	D6643
Cabriolet				
Convertible; 2-Door	Deck Lid	1994-98	2	F6572
Q3				
with Power Lift Gate	Power Liftgate	2015-18	1	PG5016
Q3 Quattro				
USA; with Power Lift Gate	Power Liftgate	2015-18	1	PG5016
Q5				
Except Power Lift Gate	Liftgate	2009-17	2	D7143

GAS CHARGED LIFT SUPPORTS ARE DESIGNED TO BE USED EXCLUSIVELY FOR THE PURPOSE SPECIFIED IN APPLICATION CHARTS. Tech Support 1-888-565-9632

MAKE & MODEL	LOCATION	YEAR	QTY	PART
Audi (cont.)				
Q7				
	Hood	2007-15	2	D6692
Except Power Liftgate	Liftgate	2007-15	2	D7053
with Power Lift Gate	Liftgate, Gas Charged	2007-15	2	D7051
Quattro				
	Hatch	1983-86	2	C4308
RS4				
	Hood	2008	2	B6444
	Trunk Lid	2007-08	2	E6282
RS5				
Coupe; 2-Door	Hood	2013-16	1	B7150
Convertible	Trunk Lid	2014-15	1	E7144
Convertible; 2-Door	Hood	2013-15	1	B7150
Coupe	Trunk Lid	2013-15	1	E7058
Coupe; 2-Door	Hood	2011	1	B7150
RS6				
	Hood	2003-04	1	B4989
	Trunk Lid	2003-04	2	E6622
RS7				
	Hood	2014-16	2	E7159
S4				
Sedan; 4-Door	Hood	2010-16	1	B7150
	Trunk Lid	2010-11	2	E6282
	Hood	2006-09	2	B6444
	Trunk Lid	2006-08	2	E6282
Wagon; 4-Door; Avant	Hatch	2004-08	2	D6291
Avant	Hood	2005	1	B6444
Base	Hood	2005	1	B6444
Cabriolet	Hood	2005	1	C7121
	Hood	2004	2	B6444
B5 Body; Avant	Hatch	2001-02	2	D6526
	Hood	2000-02	1	B6316
Sedan; 4-Door	Trunk Lid	2000-02	2	E4117
Base	Hatch	2000	1	D6526
	Hood	1992-94	2	A7149
Sedan; 4-Door	Trunk Lid	1992-94	2	D6426
S5				
Coupe	Trunk Lid	2011-21	1	E7058
Coupe; 2-Door	Hood	2008-20	1	B7150
Hatchback; 4-Door	Hood	2018	1	B7150
Convertible	Trunk Lid	2011-17	2	E7144
Convertible; 2-Door	Hood	2010-17	1	B7150
Hatchback; 4-Door	Hood	2014-16	1	B7150
	Trunk Lid	2010	2	E7144
Coupe	Trunk Lid	2008-09	1	E7058
S6				
	Hood	2013-18	2	E7159
	Trunk Lid	2013-18	1	D7059

MAKE & MODEL	LOCATION	YEAR	QTY	PART
Audi (cont.)				
S6 (cont.)				
	Hood	2010-11	2	E7159
with Spoiler	Hood	2007-09	1	B6569
	Trunk Lid	2007-08	2	E6282
	Hood	2002-03	1	B4989
	Hood	1995-96	1	A6340
Sedan; 4-Door	Trunk Lid	1995-96	2	D6426
S7				
	Hood	2013-18	2	E7159
S8				
	Hood	2007-09	2	E6294
with Power Trunk	Trunk Lid	2007-09	2	E6571
	Hood	2001-03	2	D6354
	Trunk Lid	2001-03	2	D6431
SQ5				
Except Power Lift Gate	Liftgate	2014-17	2	D7143
TT				
Convertible	Deck Lid	2001-06	2	E6573
Coupe	Hatch	2000-06	2	E6637
	Hood	2000-06	2	E6446
	Trunk Lid	2000-06	2	D6421
TT Quattro				
Convertible	Deck Lid	2001-06	2	E6573
Coupe	Hatch	2001-06	2	E6637
	Hood	2000-06	2	E6446
	Trunk Lid	2000-06	2	D6421
V8 Quattro				
	Hood	1990-94	2	D4621
BMW				
128i				
	Hood	2008-13	2	E7054
228i				
	Hood	2014-16	2	F6025
228i xDrive				
	Hood	2015-16	2	F6025
318i				
	Hood	1998	2	E4637
Sedan; 4-Door	Trunk Lid	1992-98	2	E4471
Convertible; 2-Door	Deck Lid	1994-97	2	E4046
Convertible	Hood	1994-97	2	E6341
Sedan	Hood	1994-97	2	E4637
	Hood	1993	2	E4637
Convertible; 2-Door	Deck Lid	1992	2	E4046
Sedan	Hood	1992	2	E4637
Convertible	Trunk Lid	1992	2	D4347
	Hood	1991	2	F4470
E30 Body	Trunk Lid	1991	2	D4347
	Hood	1984-85	2	F4470

GAS CHARGED LIFT SUPPORTS ARE DESIGNED TO BE USED EXCLUSIVELY FOR THE PURPOSE SPECIFIED IN APPLICATION CHARTS.

Tech Support 1-888-565-9632

APPLICATION GUIDE / GUÍA DE APLICACIONES / GUIDE D'APPLICATIONS



MAKE & MODEL	LOCATION	YEAR	QTY	PART
BMW (cont.)				
318i (cont.)				
E30 Body	Trunk Lid	1984-85	2	D4347
318is				
Coupe; 2-Door	Trunk Lid	1992-99	2	E4471
	Hood	1992-97	2	E6341
	Hood	1991	2	F4470
318ti				
E36 Body	Hatch	1995-99	2	C6368
	Hood	1995-99	2	E4637
320i				
To 08/2016; Late Design	Trunk Lid	2017	2	E6018
	Hood	2014-16	2	F6025
Late Design	Trunk Lid	2013-16	2	E6018
320i xDrive				
To 08/2016; Late Design	Trunk Lid	2017	2	E6018
Late Design	Trunk Lid	2013-16	2	E6018
323Ci				
Convertible; 2-Door; E46 Body	Deck Lid	2000	2	E6437
	Hood	2000	2	E4115
Coupe; 2-Door	Trunk Lid	2000	2	E4124
323i				
Sedan; 4-Door	Trunk Lid	2000-01	2	E4124
Wagon; 4-Door; E46 Body	Hatch	2000	2	C6283
Wagon; 4-Door	Hood	2000	2	E4115
Sedan; 4-Door	Hood	1999-00	2	E4115
Convertible	Hood	1999	2	E6341
Convertible; 2-Door	Deck Lid	1998-99	2	E4046
Sedan; 4-Door	Trunk Lid	1997-99	2	E4471
	Hood	1998	2	E6341
323is				
	Hood	1998-99	2	E6341
Coupe; 2-Door	Trunk Lid	1998-99	2	E4471
325				
	Hood	1987-88	2	F4470
325Ci				
Convertible; 2-Door; E46 Body	Deck Lid	2001-06	2	E6437
E46 Body	Hood	2001-06	2	E4115
Coupe; 2-Door	Trunk Lid	2001-06	2	E4124
325e				
	Hood	1984-87	2	F4470
E30 Body	Trunk Lid	1984-87	2	D4347
325i				
	Hood	2006	2	E6650
	Trunk Lid	2006	2	E6651
Wagon; 4-Door; E46 Body	Hatch	2001-05	2	C6283
Sedan; 4-Door; E46 Body	Hood	2001-05	2	E4115
Wagon; 4-Door; E46 Body	Hood	2001-05	2	E4115

MAKE & MODEL	LOCATION	YEAR	QTY	PART
BMW (cont.)				
325i (cont.)				
Sedan; 4-Door	Trunk Lid	2001-05	2	E4124
Convertible; 2-Door	Deck Lid	1992-95	2	E4046
	Hood	1992-95	2	E4637
E30 Body	Trunk Lid	1987-93	2	D4347
	Hood	1987-91	2	F4470
Convertible; 2-Door; Thru 04/1989	Deck Lid	1987-89	2	D4788
325is				
	Hood	1992-95	2	E6341
Coupe; 2-Door	Trunk Lid	1992-95	2	E4471
	Hood	1987-91	2	F4470
E30 Body	Trunk Lid	1987-91	2	D4347
325iX				
	Hood	1988-91	2	F4470
E30 Body	Trunk Lid	1988-91	2	D4347
325xi				
	Hood	2006	2	E6650
	Trunk Lid	2006	2	E6651
Wagon; 4-Door; E46 Body	Hatch	2001-05	2	C6283
Sedan; 4-Door	Hood	2001-05	2	E4115
Wagon; 4-Door	Hood	2001-05	2	E4115
Sedan; 4-Door	Trunk Lid	2001-05	2	E4124
328Ci				
E46 Body	Hood	2000	2	E4115
Coupe; 2-Door	Trunk Lid	2000	2	E4124
328d				
To 08/2016; Late Design	Trunk Lid	2017	2	E6018
Late Design	Trunk Lid	2014-16	2	E6018
	Hood	2014-15	2	F6025
328d xDrive				
To 08/2016; Late Design	Trunk Lid	2017	2	E6018
Late Design	Trunk Lid	2014-16	2	E6018
	Hood	2014-15	2	F6025
328i				
Late Design	Trunk Lid	2014-16	2	E6018
Front; Base	Hood	2013-16	2	F6025
Convertible; L6 3.0L 2996cc	Trunk Lid	2012-13	1	C6840
Coupe	Trunk Lid	2012-13	1	E6028
L4 2.0L 1997cc 122cid; Late Design	Trunk Lid	2012-13	1	E6018
Convertible	Deck Lid	2007-13	2	C6867
	Hood	2007-12	2	E6650
	Liftgate	2007-12	2	C7073
Convertible	Trunk Lid	2007-11	2	C6840
Coupe	Trunk Lid	2007-11	2	E6028
Sedan	Trunk Lid	2007-11	2	E6651
E46 Body	Hood	1999-00	2	E4115

GAS CHARGED LIFT SUPPORTS ARE DESIGNED TO BE USED EXCLUSIVELY FOR THE PURPOSE SPECIFIED IN APPLICATION CHARTS. Tech Support 1-888-565-9632

MAKE & MODEL	LOCATION	YEAR	QTY	PART
BMW (cont.)				
328i (cont.)				
Sedan; 4-Door	Trunk Lid	1999-00	2	E4124
Convertible; 2-Door	Deck Lid	1996-99	2	E4046
E36 Body	Hood	1996-99	2	E6341
Sedan	Hood	1996-98	2	E4637
Sedan; 4-Door	Trunk Lid	1996-98	2	E4471
328i GT xDrive				
	Hood	2014-16	2	F6025
328i xDrive				
	Hood	2013-16	2	F6025
Late Design	Trunk Lid	2013-16	2	E6018
Coupe; L6 3.0L 2996cc; N51B30A	Trunk Lid	2013	1	E6028
Coupe; L6 3.0L 2996cc; N52	Trunk Lid	2013	1	E6028
Sedan; L6 3.0L 2996cc; N51B30A	Trunk Lid	2013	1	E6651
	Trunk Lid	2012	2	E6028
	Hood	2009-12	2	E6650
	Liftgate	2009-12	2	C7073
Coupe	Trunk Lid	2010-11	2	E6028
Sedan	Trunk Lid	2010-11	2	E6651
	Trunk Lid	2009	2	E6651
328is				
	Hood	1996-99	2	E6341
Coupe; 2-Door	Trunk Lid	1996-99	2	E4471
328xi				
	Hood	2007-08	2	E6650
Wagon	Liftgate	2007-08	2	C7073
Coupe	Trunk Lid	2007-08	2	E6028
Sedan; 4-Door	Trunk Lid	2007-08	2	E6651
330Ci				
Convertible; 2-Door; E46 Body	Deck Lid	2001-06	2	E6437
	Hood	2001-06	2	E4115
Coupe; 2-Door	Trunk Lid	2001-06	2	E4124
330e				
iPerformance; To 08/2016; Late Design	Trunk Lid	2017	1	E6018
Base; To 08/2016; Late Design	Trunk Lid	2016	2	E6018
330i				
	Hood	2006	2	E6650
	Trunk Lid	2006	2	E6651
	Hood	2001-05	2	E4115
Sedan; 4-Door	Trunk Lid	2001-05	2	E4124
330xi				
	Hood	2006	2	E6650
	Trunk Lid	2006	2	E6651
	Hood	2001-05	2	E4115

MAKE & MODEL	LOCATION	YEAR	QTY	PART
BMW (cont.)				
330xi (cont.)				
Sedan; 4-Door	Trunk Lid	2001-05	2	E4124
335d				
	Hood	2009-11	2	E6650
	Trunk Lid	2009-11	2	E6651
335i				
Late Design	Trunk Lid	2014-15	2	E6018
	Hood	2012-15	2	F6025
Sedan; Late Design	Trunk Lid	2012-13	2	E6018
Convertible	Deck Lid	2010-13	2	C6867
Convertible	Trunk Lid	2010-13	2	C6840
Coupe	Trunk Lid	2007-13	2	E6028
	Hood	2007-11	2	E6650
Sedan	Trunk Lid	2007-11	2	E6651
335i GT xDrive				
	Hood	2014-16	2	F6025
335i xDrive				
Late Design	Trunk Lid	2014-15	2	E6018
	Hood	2013-15	2	F6025
Coupe	Trunk Lid	2013	2	E6028
Sedan; Late Design	Trunk Lid	2013	1	E6018
	Trunk Lid	2012	2	E6028
Coupe	Trunk Lid	2010-11	2	E6028
Sedan	Trunk Lid	2010-11	1	E6651
	Hood	2009-11	2	E6650
	Trunk Lid	2009	2	E6651
335is				
Convertible	Deck Lid	2012-13	2	C6867
Convertible	Trunk Lid	2012-13	2	C6840
Coupe	Trunk Lid	2011-13	2	E6028
	Hood	2011	2	E6650
Convertible	Trunk Lid	2011	2	E6651
335xi				
	Hood	2007-08	2	E6650
	Trunk Lid	2007-08	2	E6651
340i				
To 08/2016; Late Design	Trunk Lid	2017	2	E6018
Late Design	Trunk Lid	2016	2	E6018
340i xDrive				
To 08/2016; Late Design	Trunk Lid	2017	2	E6018
Late Design	Trunk Lid	2016	2	E6018
428i				
	Hood	2014-16	2	F6025
428i Gran Coupe				
	Hood	2015-16	2	F6025
428i xDrive				
	Hood	2014-16	2	F6025
428i xDrive Gran Coupe				
	Hood	2015-16	2	F6025

GAS CHARGED LIFT SUPPORTS ARE DESIGNED TO BE USED EXCLUSIVELY FOR THE PURPOSE SPECIFIED IN APPLICATION CHARTS.

Tech Support 1-888-565-9632

APPLICATION GUIDE / GUÍA DE APLICACIONES / GUIDE D'APPLICATIONS



MAKE & MODEL	LOCATION	YEAR	QTY	PART
BMW (cont.)				
435i				
	Hood	2014	2	F6025
435i xDrive				
Except Power Retractable	Hood	2014	2	F6025
435i xDrive Gran Coupe				
	Hood	2015-16	2	F6025
524td				
E28 Body	Hood	1985-86	2	D4507
525i				
	Hood	2004-07	2	E6481
	Back Glass	2001-03	2	F6696
	Hood	2001-03	2	E4541
E39 Body	Trunk Lid	2001-03	2	E4539
Wagon; 4-Door	Tailgate	1993-95	2	B4990
E34 Body	Hood	1989-95	2	F4024
E34 Body; with Spoiler	Trunk Lid	1989-95	2	E6272
E34 Body; without Spoiler	Trunk Lid	1989-95	2	E4472
525iT				
Wagon; 4-Door; E34 Body	Hood	1993	2	F4024
Wagon; 4-Door; E34 Body	Trunk Lid	1993	2	E4472
525xi				
	Hood	2006-07	2	E6481
528e				
E28 Body	Hood	1982-88	2	D4507
528i				
	Hood	2012-16	2	E6024
	Hood	2008-10	2	E6481
	Back Glass	1999-00	2	F6696
	Hood	1997-00	2	E4541
E39 Body	Trunk Lid	1997-00	2	E4539
528i xDrive				
	Hood	2012-16	2	E6024
	Hood	2009-10	2	E6481
528xi				
	Hood	2008	2	E6481
530i				
	Hood	2004-07	2	E6481
E60 Body; without Spoiler	Trunk Lid	2004-06	2	E4472
	Hood	2001-03	2	E4541
E39 Body	Trunk Lid	2001-03	2	E4539
E34 Body	Hood	1994-95	2	F4024
Wagon; 4-Door	Tailgate	1994-95	2	B4990
E34 Body; with Spoiler	Trunk Lid	1994-95	2	E6272
E34 Body; without Spoiler	Trunk Lid	1994-95	2	E4472
530xi				
	Hood	2006-07	2	E6481
533i				
E28 Body	Hood	1983-84	2	D4507

MAKE & MODEL	LOCATION	YEAR	QTY	PART
BMW (cont.)				
535d				
	Hood	2014-15	2	E6024
535d xDrive				
	Hood	2014-16	2	E6024
535i				
	Hood	2012-16	2	E6024
	Hood	2008-10	2	E6481
E34 Body; with Spoiler	Trunk Lid	1991-93	2	E6272
E34 Body	Hood	1989-93	2	F4024
E34 Body; without Spoiler	Trunk Lid	1989-93	2	E4472
E28 Body	Hood	1985-88	2	D4507
535i GT				
	Hatch	2010-17	2	E7161
535i GT xDrive				
	Hatch	2011-17	2	E7161
535i xDrive				
	Hood	2012-16	2	E6024
	Hood	2009-10	2	E6481
535is				
E28 Body	Hood	1988	2	D4507
535xi				
	Hood	2008	2	E6481
540i				
	Back Glass	1999-03	2	F6696
	Hood	1997-03	2	E4541
E39 Body; with Spoiler	Trunk Lid	1997-03	2	E4539
E39 Body; without Spoiler	Trunk Lid	1997-03	2	E4472
E34 Body	Hood	1994-95	2	F4024
E34 Body; with Spoiler	Trunk Lid	1994-95	2	E6272
E34 Body; without Spoiler	Trunk Lid	1994-95	2	E4472
545i				
	Hood	2004-06	2	E6481
550i				
	Hood	2012-16	2	E6024
	Hood	2006-10	2	E6481
550i GT				
	Hatch	2010-15	2	E7161
	Hood	2011	2	E6024
550i GT xDrive				
	Hatch	2010-17	2	E7161
	Hood	2011	2	E6024
550i xDrive				
	Hood	2012-16	2	E6024
633CSi				
E24 Body	Hood	1978-84	2	D4338
635CSi				
E24 Body	Hood	1985-89	2	D4338
640i				
Convertible	Deck Lid	2012-18	2	E6023

GAS CHARGED LIFT SUPPORTS ARE DESIGNED TO BE USED EXCLUSIVELY FOR THE PURPOSE SPECIFIED IN APPLICATION CHARTS. Tech Support 1-888-565-9632

MAKE & MODEL	LOCATION	YEAR	QTY	PART
BMW (cont.)				
640i (cont.)				
	Hood	2012-17	2	E6024
Coupe; 2-Door; To 07/2013	Trunk Lid	2012-14	2	D6010
640i Gran Coupe				
	Hood	2013-16	2	E6024
640i xDrive				
Convertible	Deck Lid	2014-18	2	E6023
	Hood	2014-17	2	E6024
Coupe; 2-Door; To 07/2013	Trunk Lid	2014	2	D6010
640i xDrive Gran Coupe				
	Hood	2014	2	E6024
645Ci				
	Hood	2004-05	2	E6577
650i				
Convertible	Deck Lid	2012-18	2	E6023
	Hood	2013-16	2	E6024
Coupe; 2-Door; To 07/2013	Trunk Lid	2013-14	2	D6010
	Hood	2008-10	2	E6577
650i Gran Coupe				
	Hood	2013-14	2	E6024
650i xDrive				
Convertible	Deck Lid	2012-18	2	E6023
	Hood	2012-14	2	E6024
Coupe; 2-Door; To 07/2013	Trunk Lid	2012-14	2	D6010
650i xDrive Gran Coupe				
	Hood	2013-14	2	E6024
733i				
E23 Body	Hood	1978-84	2	D4628
735i				
	Hood	1988-92	2	F4023
E32 Body	Trunk Lid	1987-92	2	F4025
E23 Body	Hood	1985-87	2	D4628
735iL				
	Hood	1988-92	2	F4023
E32 Body	Trunk Lid	1988-92	2	F4025
740i				
	Hood	2011-12	2	F6870
with Steel Hood	Hood	1997-01	2	E4540
	Trunk Lid	1997-01	2	D4546
with Steel Hood	Hood	1995	2	E4540
	Trunk Lid	1995	2	D4546
	Hood	1993-94	2	F4023
E32 Body	Trunk Lid	1993-94	2	F4025
740iL				
with Steel Hood	Hood	1995-01	2	E4540
	Trunk Lid	1995-01	2	D4546
	Hood	1993-94	2	F4023
E32 Body	Trunk Lid	1993-94	2	F4025

MAKE & MODEL	LOCATION	YEAR	QTY	PART
BMW (cont.)				
740Li				
Left; w/o Wiper; with Power Lift Gate	Power Liftgate	2011-15	1	PG5012L
Right; with Power Lift Gate	Power Liftgate	2011-15	1	PG5012R
	Hood	2011-12	2	F6870
745i				
	Hood	2002-05	2	B6245
745Li				
	Hood	2002-05	2	B6245
750i				
	Hood	2011-12	2	F6870
	Hood	2010	2	B6245
	Hood	2006-08	2	B6245
750i xDrive				
	Hood	2011-12	2	F6870
750iL				
with Aluminum Hood	Hood	1995-01	2	E6697
with Steel Hood	Hood	1995-01	2	E4540
	Trunk Lid	1995-01	2	D4546
	Hood	1988-94	2	F4023
E32 Body	Trunk Lid	1988-94	2	F4025
750Li				
	Hood	2011-12	2	F6870
	Hood	2010	2	B6245
	Hood	2006-08	2	B6245
750Li xDrive				
	Hood	2011-12	2	F6870
760i				
	Hood	2004-06	2	B6245
760Li				
	Hood	2011	2	F6870
	Hood	2010	2	B6245
	Hood	2003-08	2	B6245
840Ci				
	Hood	1994-97	2	E4544
E31 Body	Trunk Lid	1994-97	2	D4545
850Ci				
	Hood	1993-97	2	E4544
E31 Body	Trunk Lid	1993-97	2	D4545
850CSi				
	Hood	1994-95	2	E4544
E31 Body	Trunk Lid	1994-95	2	D4545
850i				
	Hood	1991-92	2	E4544
E31 Body	Trunk Lid	1991-92	2	D4545
ActiveHybrid 3				
Late Design	Trunk Lid	2013-15	2	E6018
ActiveHybrid 5				
	Hood	2012-16	2	E6024

GAS CHARGED LIFT SUPPORTS ARE DESIGNED TO BE USED EXCLUSIVELY FOR THE PURPOSE SPECIFIED IN APPLICATION CHARTS.

Tech Support 1-888-565-9632

APPLICATION GUIDE / GUÍA DE APLICACIONES / GUIDE D'APPLICATIONS



MAKE & MODEL	LOCATION	YEAR	QTY	PART
BMW (cont.)				
Alpina B6 xDrive Gran Coupe				
	Hood	2015-17	2	E6024
Alpina B7				
	Hood	2011-12	2	F6870
	Hood	2007-08	2	B6245
Alpina B7 xDrive				
	Hood	2011-12	2	F6870
Alpina B7L				
	Hood	2011-12	2	F6870
Alpina B7L xDrive				
	Hood	2011-12	2	F6870
L7				
E23 Body	Hood	1986-87	2	D4628
M235i				
	Hood	2014-16	2	F6025
M235i xDrive				
	Hood	2015-16	2	F6025
M3				
To 08/2016; Late Design	Trunk Lid	2017	2	E6018
Late Design	Trunk Lid	2015-16	1	E6018
Convertible	Deck Lid	2008-13	2	C6867
Convertible	Trunk Lid	2008-13	2	C6840
Coupe	Trunk Lid	2008-13	2	E6028
Sedan	Trunk Lid	2008-11	2	E6651
Coupe; 2-Door	Trunk Lid	2003-06	2	E4124
Convertible; 2-Door; E46 Body	Deck Lid	2001-06	2	E6437
	Hood	2001-06	2	E6533
Coupe; 2-Door	Trunk Lid	2001-02	2	C6578
Coupe; 2-Door	Trunk Lid	1999	2	C6578
	Hood	1995-99	1	E6341
Sedan; 4-Door	Trunk Lid	1997-98	2	E4471
Coupe; 2-Door	Trunk Lid	1995-98	2	E4471
E30 Body	Trunk Lid	1988-91	2	D4347
M5				
	Hood	2013-14	2	E6024
	Hood	2006-10	2	E6481
	Hood	2000-03	2	E4541
E39 Body	Trunk Lid	2000-03	2	E4539
E34 Body	Hood	1991-93	2	F4024
E34 Body; with Spoiler	Trunk Lid	1991-93	2	E6272
E34 Body; without Spoiler	Trunk Lid	1991-93	2	E4472
E28 Body	Hood	1988	2	D4507
M6				
Convertible	Deck Lid	2012-18	2	E6023
	Hood	2012-14	2	E6024
	Hood	2006-10	2	E6577
E24 Body	Hood	1987-88	2	D4338

MAKE & MODEL	LOCATION	YEAR	QTY	PART
BMW (cont.)				
M6 Gran Coupe				
	Hood	2014-16	2	E6024
X1				
	Hood	2013-15	2	E7126
	Liftgate	2010-15	2	C7127
X3				
sDrive28i	Hood	2015-17	2	E6846
xDrive28d	Hood	2015-17	2	E6846
xDrive28i	Hatch	2011-17	2	C6845
xDrive35i	Hatch	2011-17	2	C6845
xDrive28i	Hood	2011-17	2	E6846
xDrive35i	Hood	2011-17	2	E6846
Left; with Power Lift Gate	Power Liftgate	2011-17	1	PG5011L
Right; with Power Lift Gate	Power Liftgate	2011-17	1	PG5011R
xDrive30i	Hood	2009-10	2	E6359
	Hatch	2004-10	2	C6136
3.0si	Hood	2007-08	2	E6359
3.0i	Hood	2004-06	2	E6359
2.5i	Hood	2004-05	2	E6359
X4				
M40i	Hood	2016-18	2	E6846
xDrive28i	Hood	2015-18	2	E6846
xDrive35i	Hood	2015-16	2	E6846
X5				
	Hood	2007-13	2	E6768
Left; with Power Lift Gate	Power Liftgate	2007-13	1	PG5000L
Right; with Power Lift Gate	Power Liftgate	2007-13	1	PG5000R
4.8is	Back Glass	2004-06	2	D6616
3.0i	Back Glass	2001-06	2	D6616
4.4i	Back Glass	2000-06	2	D6616
	Hood	2000-06	2	E4116
4.6is	Back Glass	2002-03	2	D6616
X6				
	Hood	2008-14	1	E6768
Z3				
Convertible; 2-Door; M Roadster	Deck Lid	1999-02	2	F4051
Coupe; 2-Door; E36 Body	Hatch	1999-02	2	C6438
Coupe; Coupe	Hood	1999-02	2	E4522
Coupe; M Coupe	Hood	1999-02	2	E4522
Coupe; 2-Door	Trunk Lid	1999-02	2	C6578
Convertible; M Roadster	Hood	1998-02	2	E4522
Convertible; 2-Door; Roadster	Deck Lid	1996-02	2	F4030
Convertible; Roadster	Hood	1996-02	2	E4522
Z4				
Convertible; 2-Door; M Roadster	Deck Lid	2006-09	2	E6259

GAS CHARGED LIFT SUPPORTS ARE DESIGNED TO BE USED EXCLUSIVELY FOR THE PURPOSE SPECIFIED IN APPLICATION CHARTS. Tech Support 1-888-565-9632

MAKE & MODEL	LOCATION	YEAR	QTY	PART
BMW (cont.)				
Z4 (cont.)				
Convertible; 2-Door; Roadster 3.0si	Deck Lid	2006-08	2	E6259
	Hood	2003-08	2	D6258
Convertible; 2-Door; 2.5i	Deck Lid	2003-05	2	E6259
Convertible; 2-Door; 3.0i	Deck Lid	2003-05	2	E6259
Z8				
	Deck Lid	2000-03	2	F6581
	Hood	2000-03	2	C6580
Buick				
Allure				
CAN	Trunk Lid	2005-09	2	E4069
CAN	Hood	2005-07	2	C4150
Apollo				
	Trunk Lid	1975	2	C4701
Cascada				
	Trunk Lid	2016-19	2	E7128
Century				
From VIN # 500771	Trunk Lid	1999-05	2	E4122
	Hood	1997-05	2	C4295
To VIN # 500770	Trunk Lid	1997-99	2	E4519
	Back Glass	1984-96	2	D4447
Wagon; 4-Door	Hatch	1984-96	2	C4776
	Hood	1982-96	2	E4428
	Trunk Lid	1979-85	2	F4002
with Steel Hood	Hood	1981	2	E4428
Wagon; 4-Door	Back Glass	1978-81	2	D4404
with Aluminum Hood	Hood	1978-81	2	E4491
	Hatch	1975-77	2	C4701
Commercial Chassis				
	Hood	1991-96	2	C4755
Electra				
	Hood	1985-90	2	E4444
	Trunk Lid	1979-85	2	F4002
with Steel Hood	Hood	1980-84	2	F4103
Enclave				
	Hatch	2008-17	2	C6165
	Hood	2008-17	1	C6164
Encore				
	Liftgate	2013-18	2	C6875
Estate Wagon				
with Steel Hood	Hood	1982-83	2	E4491
without Steel Hood	Hood	1980-83	2	F4103
with Steel Hood	Hood	1981	2	E4428
LaCrosse				
	Hood	2014-16	1	C7062
	Hood	2010-13	1	C6299
	Trunk Lid	2010-13	1	D6848
	Hood	2008-09	2	C6792

MAKE & MODEL	LOCATION	YEAR	QTY	PART
Buick (cont.)				
LaCrosse (cont.)				
	Trunk Lid	2005-09	2	E4069
	Hood	2005-07	2	C4150
LeSabre				
2nd Design	Hood	2005	1	A6582
1st Design	Hood	2000-05	2	A4986
	Trunk Lid	1998-99	2	E4519
	Hood	1992-99	2	D4687
with Steel Hood	Hood	1980-90	2	F4103
	Trunk Lid	1979-85	2	F4002
Lucerne				
	Hood	2006-11	1	B6159
Park Avenue				
	Hood	1997-05	2	C4344
	Hood	1993-96	2	D4627
Rainier				
	Back Glass	2004-07	2	C4576
	Hatch	2004-07	2	C4573
Reatta				
	Hood	1988-91	2	B4830
	Trunk Lid	1988-91	2	D4614
Regal				
	Hood	2011-17	2	B6483
	Trunk Lid	2011-17	2	E7132
From VIN # 500771	Trunk Lid	1999-04	2	E4122
	Hood	1997-04	2	C4295
To VIN # 500770	Trunk Lid	1997-99	2	E4519
	Hood	1993-96	2	C4463
	Hood	1988-92	2	D4496
without Steel Hood	Hood	1982-87	2	E4491
with Steel Hood	Hood	1981-87	2	E4428
Sedan; 4-Door	Trunk Lid	1982-84	2	F4002
Wagon; 4-Door	Back Glass	1982-83	2	D4404
Coupe; 2-Door	Trunk Lid	1980-82	2	F4100
with Aluminum Hood	Hood	1978-81	2	E4491
Rendezvous				
	Hatch	2002-07	2	B4992
	Hood	2002-07	2	E4359
Riviera				
	Hood	1995-99	2	A4965
	Trunk Lid	1995-99	2	C4966
	Hood	1986-93	2	B4744
	Hood	1979-85	2	E4417
	Trunk Lid	1979-83	2	F4101
Roadmaster				
Wagon; 4-Door	Back Glass	1991-96	2	D4762
	Hood	1991-96	2	C4755

GAS CHARGED LIFT SUPPORTS ARE DESIGNED TO BE USED EXCLUSIVELY FOR THE PURPOSE SPECIFIED IN APPLICATION CHARTS. Tech Support 1-888-565-9632

APPLICATION GUIDE / GUÍA DE APLICACIONES / GUIDE D'APPLICATIONS



MAKE & MODEL	LOCATION	YEAR	QTY	PART
Buick (cont.)				
Skyhawk				
Wagon; 4-Door	Tailgate	1983-89	2	C4708
	Hood	1982-89	2	E4428
	Hatch	1983-87	2	A4901
without Rear Defroster	Hatch	1979-80	2	C4445
with Rear Defroster	Hatch	1975-80	2	D4411
Skylark				
	Hood	1992-98	2	D4629
Coupe; 2-Door	Hood	1988-91	2	E4446
Sedan; 4-Door	Hood	1986-91	2	E4446
	Hood	1980-85	2	E4421
with Spoiler	Trunk Lid	1981-83	2	F4004
without Spoiler	Trunk Lid	1980-83	2	F4000
	Hatch	1975-79	2	C4701
Somerset				
Coupe; 2-Door	Hood	1986-87	2	E4446
Somerset Regal				
Coupe; 2-Door	Hood	1985	2	E4446
Terraza				
	Liftgate	2005-07	2	B4304
Cadillac				
60 Special				
	Hood	1993	2	D4627
Allante				
Convertible; 2-Door	Convertible Top Cover	1990-93	2	F6952
Convertible; 2-Door	Deck Lid	1990-93	2	D4617
	Hood	1987-93	2	B4821
ATS				
	Hood	2013-19	2	D6868
Brougham				
	Hood	1991-92	2	D4627
	Hood	1987-90	2	E4444
Catera				
	Hood	1999-01	2	C4176
	Trunk Lid	1997-01	2	D4350
	Hood	1997-98	2	C4337
Commercial Chassis				
RWD	Hood	1993-96	2	D4635
Cab & Chassis; 4-Door; FWD; Base	Hood	1991-93	2	D4627
	Hood	1985-90	2	E4444
	Trunk Lid	1980-85	2	F4102
CTS				
Wagon; 4-Door	Hood	2014-19	2	D7025
	Hatch	2010-14	2	E6849
	Trunk Lid	2008-14	2	E6250
	Hood	2008-13	1	C6249
	Hood	2003-07	2	B6307

MAKE & MODEL	LOCATION	YEAR	QTY	PART	
Cadillac (cont.)					
CTS (cont.)					
2nd Design	Trunk Lid	2003-07	2	E6404	
1st Design	Trunk Lid	2003	2	E6414	
DeVille					
	Hood	2000-05	2	B4993	
	Hood	1997-99	2	C4289	
	Hood	1994-96	2	C4793	
	Hood	1991-93	2	D4627	
	Hood	1985-90	2	E4444	
	Trunk Lid	1980-85	2	F4102	
DTS					
	Hood	2006-11	1	B6159	
Eldorado					
	Hood	1992-02	2	C4630	
	Hood	1986-91	2	B4744	
	Hood	1979-85	2	E4417	
	Trunk Lid	1979-83	2	F4101	
Escalade					
1st Design	Back Glass	2015-20	2	D6869	
	Back Glass	2007-14	2	D6157	
	Hatch	2007-14	2	C6156	
	Hood	2007-14	2	C6155	
	Hatch	2005-06	2	C6262	
	Back Glass	2002-06	2	D4185	
	Liftgate	2002-04	2	C6235	
	Back Glass	2000	2	D4185	
	Liftgate	1999-00	2	C4557	
	Back Glass	1999	2	D4650	
	Escalade ESV				
		Back Glass	2015-20	2	D6869
		Back Glass	2007-14	2	D6157
	Hatch	2007-14	2	C6156	
	Hood	2007-14	2	C6155	
	Hatch	2005-06	2	C6262	
	Back Glass	2003-06	2	D4185	
	Liftgate	2003-04	2	C6235	
Escalade EXT					
	Back Glass	2007-13	2	D6157	
	Hatch	2007-13	2	C6156	
	Hood	2007-13	2	C6155	
	Back Glass	2002-06	2	D4185	
	Liftgate	2002-04	2	C6235	
Fleetwood					
	Hood	1993-96	2	D4635	
	Hood	1991-92	2	D4627	
	Hood	1985-90	2	E4444	
	Trunk Lid	1980-85	2	F4102	

GAS CHARGED LIFT SUPPORTS ARE DESIGNED TO BE USED EXCLUSIVELY FOR THE PURPOSE SPECIFIED IN APPLICATION CHARTS. Tech Support 1-888-565-9632

MAKE & MODEL	LOCATION	YEAR	QTY	PART
Cadillac (cont.)				
Seville				
	Hood	2000-04	2	A4991
	Hood	1998-99	2	A4965
	Hood	1997	2	C4563
Attached with Cylinder Up	Hood	1996	2	C4563
Attached with Cylinder Down	Hood	1992-96	2	C4630
	Hood	1986-91	2	B4744
	Trunk Lid	1980-85	2	F4426
	Hood	1979-85	2	E4417
SRX				
	Hood	2010-16	1	C6376
with Power Lift Gate	Liftgate, Gas Charged	2010-16	1	C6377
without Power Lift Gate	Liftgate	2010-16	2	C7180
	Hatch	2004-09	2	D6116
	Hood	2004-09	2	D4398
STS				
	Hood	2005-11	2	B6168
	Trunk Lid	2005-11	2	E6169
XLR				
	Hood	2004-09	2	B6241
Convertible	Trunk Lid	2004-09	2	E7147
XTS				
	Hood	2018-19	1	C7119
	Trunk Lid	2013-19	1	C7120
	Hood	2013-17	1	C7068
Chevrolet				
Astra				
MEX	Tailgate	2000-04	2	C7184
MEX	Hatch	2001-03	2	D6554
MEX	Hood	2001-03	2	E6558
Astro				
	Back Glass	2001-05	2	C6610
	Back Glass	1992-00	2	C4219
Avalanche				
	Hood	2007-13	2	C6155
Aveo				
	Hatch	2004-11	2	E6500
Aveo5				
	Hatch	2006-11	2	E6500
Blazer				
2-Door	Back Glass	1995-05	2	D4642
4-Door; with Droptate	Back Glass	1995-05	2	D4316
with Droptate	Tailgate	1995-05	2	F4531
4-Door; with Liftgate	Hatch	2002-03	2	C4287
4-Door; with Liftgate	Back Glass	1997-03	2	C4799
4-Door; with Liftgate; with Steel Liftgate	Hatch	2000-01	2	C4287
with Aluminum Liftgate	Liftgate	2000-01	2	C6101

MAKE & MODEL	LOCATION	YEAR	QTY	PART
Chevrolet (cont.)				
Blazer (cont.)				
4-Door; with Liftgate	Hatch	1997-99	2	C4287
1st Design; with Rear Defroster	Back Glass	1994	2	D4190
2nd Design; without Rear Defroster; without Rear Wiper	Back Glass	1994	2	D4184
with Rear Defroster	Back Glass	1992-93	2	D4190
C1500 Suburban				
2nd Design; with Rear Defroster	Back Glass	1994-99	2	D4184
without Rear Defroster	Back Glass	1992-99	2	D4650
C2500 Suburban				
without Rear Defroster	Back Glass	1994-99	2	D4650
Camaro				
Convertible; 2-Door; with Spoiler	Deck Lid	2014-15	2	F6874
	Hood	2010-15	1	B6182
Coupe; 2-Door; with Spoiler	Trunk Lid	2010-15	2	E6183
Coupe; 2-Door; without Spoiler	Trunk Lid	2010-15	2	F6866
Convertible; 2-Door	Deck Lid	2011-13	2	F6817
Base	Hood	1998-02	2	C4542
Z28	Hood	1998-02	2	C4542
Z28 SS	Hood	1998-02	2	C4542
Rear; Convertible	Deck Lid	1993-02	2	E4529
	Hatch	1993-02	2	B4860
	Hood	1993-97	2	C4794
Rear; Convertible	Deck Lid	1987-92	2	E4632
with Spoiler; with Wiper; with Rear Window Sunshade	Hatch	1982-92	2	A4900
with Spoiler; with Wiper; without Rear Window Sunshade	Hatch	1982-92	2	A4954
without Spoiler; without Wiper	Hatch	1982-92	2	A4967
with Fiberglass Hood	Hood	1982-92	2	E4134
with Steel Hood	Hood	1982-92	2	E4422
Caprice				
	Trunk Lid	2011-17	2	E6556
Wagon; 4-Door	Back Glass	1991-96	2	D4762
	Hood	1991-96	2	C4755
Sedan; 4-Door	Trunk Lid	1980-83	2	F4002
Captiva Sport				
	Hood	2012-15	2	D6242
	Liftgate	2012-15	2	C6243
Cavalier				
Convertible; 2-Door	Deck Lid	1995-00	2	E4113
Wagon; 4-Door	Tailgate	1982-94	2	C4708
	Hatch	1982-87	2	A4901
Celebrity				
	Back Glass	1984-90	2	D4447

GAS CHARGED LIFT SUPPORTS ARE DESIGNED TO BE USED EXCLUSIVELY FOR THE PURPOSE SPECIFIED IN APPLICATION CHARTS.

Tech Support 1-888-565-9632

APPLICATION GUIDE / GUÍA DE APLICACIONES / GUIDE D'APPLICATIONS



MAKE & MODEL	LOCATION	YEAR	QTY	PART
Chevrolet (cont.)				
Celebrity (cont.)				
Wagon; 4-Door	Hatch	1984-90	2	C4776
Chevette				
	Hatch	1976-87	2	D4411
Chevy				
MEX	Hood	2009-12	2	C6497
Hatchback; 4-Door	Hatch	2003-10	2	C6491
Hatchback; 2-Door	Hatch	2003-08	1	C6524
Citation				
	Hatch	1980-83	2	D4411
Citation II				
	Hatch	1984-85	2	D4411
Cobalt				
	Hood	2005-10	2	C6321
	Trunk Lid	2005-10	2	E6409
Commercial Chassis				
	Back Glass	1991-94	2	D4762
	Hood	1991-94	2	C4755
Corsa				
MEX	Hatch	2002-08	2	D6492
Corsica				
without Electrical End Fittings	Trunk Lid	1989-91	2	B4962
Corvette				
	Hatch	2014-19	2	E7024
	Hood	2014-19	2	E7023
	Trunk Lid	2014-19	2	E7162
with Spoiler	Hatch	2005-13	2	D6522
without Spoiler	Hatch	2005-13	2	D6508
	Hood	2005-13	2	E6330
	Trunk Lid	1997-13	2	E4066
	Convertible Top Cover	1997-04	2	F4065
Left; Hatchback	Hatch	1997-04	1	D6702L
Right; Hatchback	Hatch	1997-04	1	D6702R
	Hood	1997-04	2	E4525
	Hood	1989-96	2	A4972
Left	Hatch	1984-96	1	A4903
Right	Hatch	1984-96	1	A4904
1st Design	Hood	1988	2	F4003
2nd Design	Hood	1988	2	A4972
	Hood	1984-87	2	F4003
	Hatch	1982	2	A4973
Equinox				
without Power Lift Gate	Hatch	2010-17	2	C6019
	Hood	2010-17	1	C6470
with Power Lift Gate	Liftgate, Gas Charged	2010-16	2	C6827
	Liftgate	2005-09	2	C6108

MAKE & MODEL	LOCATION	YEAR	QTY	PART
Chevrolet (cont.)				
Express 1500				
	Cargo Van Access Panel	2003-14	2	C6900
Rear	Door	2003-14	2	D6901
Express 2500				
	Cargo Van Access Panel	2003-19	2	C6900
Rear	Door	2003-19	2	D6901
Express 3500				
	Cargo Van Access Panel	2003-19	2	C6900
Rear	Door	2003-19	2	D6901
Express 4500				
Rear; Cutaway	Door	2017-19	2	D6901
HHR				
	Hatch	2006-11	2	C6123
	Hood	2006-11	2	C6310
Impala				
	Hood	2014-20	1	B6738
	Trunk Lid	2014-20	2	D7085
without Spoiler	Trunk Lid	2009-13	2	E6672
	Hood	2006-13	1	C4582
with Spoiler	Trunk Lid	2006-13	2	E6255
without Spoiler	Trunk Lid	2006-08	2	E4071
	Hood	2000-05	2	C4295
with Spoiler	Trunk Lid	2000-05	2	E4120
without Spoiler	Trunk Lid	2000-05	2	E4119
	Hood	1994-96	2	C4755
Sedan; 4-Door	Trunk Lid	1979-83	2	F4002
Impala Limited				
	Hood	2014-16	1	C4582
with Spoiler	Trunk Lid	2014-16	2	E6255
without Spoiler	Trunk Lid	2014-16	1	E6672
K1500 Suburban				
	Back Glass	1994-99	2	D4650
K2500 Suburban				
	Back Glass	1994-99	2	D4650
Lumina				
with Spoiler	Trunk Lid	2000-01	2	E4120
without Spoiler	Trunk Lid	2000-01	2	E4119
	Hood	1995-01	2	D4640
	Hood	1993-94	2	C4463
	Hood	1990-92	2	D4496
Lumina APV				
	Hatch	1995-96	1	B4849
Mini Cargo Van	Hatch	1994	2	B4849
Mini Passenger Van; 3-Door	Hatch	1990-94	2	B4885
Mini Cargo Van	Hatch	1992	2	B4849
Mini Cargo Van	Hatch	1991	2	B4787

GAS CHARGED LIFT SUPPORTS ARE DESIGNED TO BE USED EXCLUSIVELY FOR THE PURPOSE SPECIFIED IN APPLICATION CHARTS. Tech Support 1-888-565-9632

MAKE & MODEL	LOCATION	YEAR	QTY	PART
Chevrolet (cont.)				
Malibu				
	Hood	2013-16	2	C6711
	Trunk Lid	2013-15	2	D6713
	Hood	2008-12	1	D6166
	Trunk Lid	2008-12	2	E6167
Maxx SS	Hatch	2006-07	2	D6510
Maxx LS	Hatch	2004-07	2	D6510
Maxx LT	Hatch	2004-07	2	D6510
Maxx	Hatch	2004	2	D6510
Wagon; 4-Door	Back Glass	1978-83	2	D4404
Sedan; 4-Door	Trunk Lid	1982	2	F4002
Coupe; 2-Door	Trunk Lid	1980-81	2	F4100
Sedan; 4-Door	Trunk Lid	1979	2	F4002
Malibu Limited				
	Hood	2016	2	C6711
	Trunk Lid	2016	1	D6713
Matiz				
MEX	Hatch	2011-15	2	D6495
Meriva				
MEX	Hatch	2004-08	2	D6493
Metro				
Left	Hatch	1998-01	1	B4987L
Right	Hatch	1998-01	1	B4987R
Monte Carlo				
	Hood	2006-07	1	C4582
1st Design	Hood	2005	2	C4342
2nd Design	Hood	2005	2	C6315
with Spoiler	Trunk Lid	2000-05	2	E4120
without Spoiler	Trunk Lid	2000-05	2	E4119
	Hood	2000-04	2	C4342
without Spoiler	Trunk Lid	1999	2	E6285
	Hood	1995-99	2	D4640
Coupe	Trunk Lid	1987	2	E4553
Coupe; 2-Door	Trunk Lid	1980-82	2	F4100
Monza				
without Rear Defroster	Hatch	1977-80	2	C4445
with Defroster	Hatch	1975-80	2	D4411
Wagon; 2-Door	Tailgate	1978-79	2	C4717
Nova				
	Hatch	1986-88	2	C4726
	Hatch	1975-79	2	C4701
S10 Blazer				
with Rear Defroster	Back Glass	1983-94	2	D4451
without Rear Defroster	Back Glass	1983-94	2	D4404
Sonic				
	Hatch	2012-19	2	D6787
Spark				
with Wiper	Hatch	2013-16	2	E6666

MAKE & MODEL	LOCATION	YEAR	QTY	PART
Chevrolet (cont.)				
Spark EV				
	Hatch	2014-16	2	E6666
Spectrum				
	Hatch	1985-88	2	C4452
Sprint				
	Hatch	1985-89	2	C4724
SS				
	Hood	2014-17	1	C6784
with Spoiler	Trunk Lid	2014-17	2	E6785
SSR				
Rear; Convertible; 2-Door; Tonneau Cover	Deck Lid	2003-06	2	E6902
Suburban				
	Back Glass	2016-20	1	D6869
	Back Glass	2014-15	2	D6157
	Hatch	2014	2	C6156
	Hood	2014	2	C6155
1st Design; with Rear Defroster	Back Glass	1994	2	D4190
with Rear Defroster	Back Glass	1992-93	2	D4190
Suburban 1500				
	Back Glass	2007-14	2	D6157
	Hatch	2007-14	2	C6156
	Hood	2007-14	2	C6155
2nd Design	Hatch	2005-06	2	C6151
	Back Glass	2000-06	2	D4185
1st Design	Liftgate	2000-06	2	C4557
Suburban 2500				
	Back Glass	2007-13	2	D6157
	Hatch	2007-13	2	C6156
	Hood	2007-13	2	C6155
2nd Design	Hatch	2005-06	2	C6151
	Back Glass	2000-06	2	D4185
1st Design	Liftgate	2000-06	2	C4557
Suburban 3500 HD				
	Back Glass	2016-19	1	D6869
Tahoe				
	Back Glass	2015-20	2	D6869
	Back Glass	2007-14	2	D6157
	Hatch	2007-14	2	C6156
	Hood	2007-14	2	C6155
2nd Design	Hatch	2005-06	2	C6151
	Back Glass	2000-06	2	D4185
	Liftgate	1995-05	2	C4557
2nd Design; with Rear Defroster	Back Glass	1995-99	2	D4184
without Rear Wiper	Back Glass	1995-98	2	D4184
Tracker				
Rear	Door	1998-04	1	D4560

GAS CHARGED LIFT SUPPORTS ARE DESIGNED TO BE USED EXCLUSIVELY FOR THE PURPOSE SPECIFIED IN APPLICATION CHARTS. Tech Support 1-888-565-9632

APPLICATION GUIDE / GUÍA DE APLICACIONES / GUIDE D'APPLICATIONS



MAKE & MODEL	LOCATION	YEAR	QTY	PART
Chevrolet (cont.)				
Tracker (cont.)				
Rear	Door	1990-91	1	C4789
Trailblazer				
	Back Glass	2002-09	2	C4576
	Hatch	2002-09	2	C4573
Trailblazer EXT				
129.0" WB	Back Glass	2002-06	2	D4575
129.0" WB	Liftgate	2002-06	2	C4574
Traverse				
	Hatch	2014-17	2	D6463
	Hood	2013-17	2	C6399
with Power Lift Gate	Hatch	2013	1	D6463
	Hatch	2009-12	2	D6463
	Hood	2009-12	2	C6462
Uplander				
	Liftgate	2005-09	2	B4304
Vectra				
MEX	Hatch	2003-08	2	F6494
MEX	Hood	2003-08	2	C6496
Vega				
Wagon; 2-Door	Tailgate	1974-77	2	C4717
Venture				
	Liftgate	1997-05	2	B4304
Volt				
	Hatch	2011-15	2	D7041
Chrysler				
200				
	Hood	2015-17	2	D6863
Sedan	Trunk Lid	2014	2	E6224
Convertible	Trunk Lid	2011-14	1	E6679
Sedan	Trunk Lid	2011-13	1	E6254
300				
Except Aluminum Hood	Hood	2011-21	2	E7176
with Aluminum Hood	Hood	2011-21	2	E6558
	Trunk Lid	2011-20	2	E4064
Dual Hood Lift Upgrade for Single Hood Lift Applications; May Require Lift Support Stud Purchase	Hood	2009-10	1	E6303
Single Hood Lift Application	Hood	2009-10	1	E6372
	Trunk Lid	2009-10	2	E6373
	Hood	2005-08	2	E6303
	Trunk Lid	2005-08	2	E6405
300M				
	Hood	1999-04	2	C4257
	Trunk Lid	1999-04	2	E4527
Aspen				
Limited; with Power Lift Gate	Liftgate, Gas Charged	2007-09	2	C4396
Cirrus				
Coupe; 2-Door	Trunk Lid	1998-00	2	E4477

MAKE & MODEL	LOCATION	YEAR	QTY	PART
Chrysler (cont.)				
Cirrus (cont.)				
Sedan; 4-Door	Trunk Lid	1995-00	2	E4477
Concorde				
Limited	Trunk Lid	2002-04	2	E4956
LX	Trunk Lid	1998-04	2	E4956
LXi	Trunk Lid	1998-04	2	E4956
	Hood	1998-01	2	C4256
	Hood	1993-97	2	E4468
Crossfire				
Convertible	Deck Lid	2005-08	2	F7157
Coupe	Hatch	2004-08	2	D6189
	Hood	2004-08	1	A6188
Grand Voyager				
	Hatch	2000	2	B4865
with Wiper	Liftgate	1991-95	2	C4837
Laser				
	Hatch	1984-86	2	C4712
LeBaron				
Convertible; 2-Door	Deck Lid	1987-95	2	D4457
GTS	Hatch	1985-89	2	D4436
Wagon; 4-Door	Hatch	1984-87	2	D4442
Convertible; 2-Door	Deck Lid	1984-86	2	E4456
Wagon; 4-Door	Hatch	1982	2	D4442
Wagon; 4-Door	Tailgate	1978-81	2	D4409
LHS				
	Hood	1999-01	2	C4256
	Trunk Lid	1999-01	2	E4956
	Hood	1994-97	2	E4468
New Yorker				
	Hood	1993-96	2	E4468
Hardtop; 4-Door	Hatch	1979	2	D4442
Newport				
Hardtop; 4-Door	Hatch	1979	2	D4442
Pacifica				
	Hatch	2004-08	2	C6154
Prowler				
Convertible; 2-Door	Deck Lid	2001-02	2	E4959
	Hood	2001-02	2	F4032
PT Cruiser				
Convertible; 2-Door	Deck Lid	2005-08	2	D6286
Wagon; 4-Door	Tailgate	2001-08	2	C4564
Sebring				
Sedan; 4-Door	Trunk Lid	2010	2	E6254
Convertible	Trunk Lid	2009-10	2	E6679
Convertible	Deck Lid	2008-09	2	E6170
	Trunk Lid	2007	2	E6224
with Spoiler	Trunk Lid	2001-06	2	E4045
without Spoiler	Trunk Lid	2001-06	2	E4064

GAS CHARGED LIFT SUPPORTS ARE DESIGNED TO BE USED EXCLUSIVELY FOR THE PURPOSE SPECIFIED IN APPLICATION CHARTS. Tech Support 1-888-565-9632

MAKE & MODEL	LOCATION	YEAR	QTY	PART
Chrysler (cont.)				
Sebring (cont.)				
Convertible; 2-Door; without Spoiler	Deck Lid	2001-05	2	F4070
Convertible; 2-Door	Trunk Lid	1998-00	2	F4031
Convertible; 2-Door	Trunk Lid	1996-97	2	F4027
TC Maserati				
	Hood	1989-91	2	C6327
Town & Country				
with Power Lift Gate	Liftgate, Gas Charged	2008-16	2	C6124
without Power Lift Gate	Liftgate	2008-16	2	C6257
Limited	Seat Adjustment Strut	2005-07	2	F4096
LX	Seat Adjustment Strut	2005-07	2	F4096
Touring	Seat Adjustment Strut	2005-07	2	F4096
	Liftgate	2001-07	2	C4535
	Hatch	1996-00	2	B4865
with Wiper	Liftgate	1991-95	2	C4837
without Stereo; without Wiper	Liftgate	1991-95	2	C4834
without Rear Wiper	Hatch	1990	2	C4775
without Rear Wiper	Hatch	1984-88	2	C4775
Wagon; 4-Door	Hatch	1982-88	2	D4442
Voyager				
	Liftgate	2001-03	2	C4535
	Hatch	2000	2	B4865
Daewoo				
Nubira				
Wagon; 5-Door	Hatch	1999-02	2	D6217
Daihatsu				
Charade				
Left; From 06/1987; To 01/1993; without Wiper	Hatch	1988-92	1	B4866L
Right; From 06/1987; To 01/1993; without Wiper	Hatch	1988-92	1	B4866R
DeLorean				
DMC 12				
	Door	1981-83	1	E4107
	Hood	1981-83	2	D6148
Front	Trunk Lid	1981-83	2	C6147
Dodge				
600				
Convertible; 2-Door	Deck Lid	1984-86	2	E4456
Aries				
Wagon; 4-Door	Hatch	1981-88	2	D4442
Aspen				
Wagon; 4-Door	Tailgate	1978-80	2	D4409
with Ball Type End Fittings; without Wiper	Hatch	1976-77	2	D4686

MAKE & MODEL	LOCATION	YEAR	QTY	PART
Dodge (cont.)				
Atos				
MEX	Hatch	2005-12	2	D6539
MEX	Hatch	2001-04	2	D6555
Avenger				
	Trunk Lid	2014	2	E6224
without Spoiler	Trunk Lid	2009-13	2	E6224
	Trunk Lid	2008	2	E6224
Caliber				
with Articulating Liftgate Speakers	Hatch	2007-12	2	D6256
without Articulating Liftgate Speakers	Hatch	2007-12	2	D6216
Caravan				
	Liftgate	2001-07	2	C4535
	Hatch	1996-00	2	B4865
with Wiper	Liftgate	1991-95	2	C4837
without Stereo; without Wiper	Liftgate	1991-95	2	C4834
without Rear Wiper	Hatch	1984-90	2	C4775
Challenger				
	Hood	2008-21	2	E6378
	Trunk Lid	2008-21	2	E6657
Charger				
Except Aluminum Hood	Hood	2011-21	2	E7176
with Aluminum Hood	Hood	2011-21	2	E6558
without Rear Spoiler	Trunk Lid	2006-20	2	E4064
	Hood	2006-10	2	E6303
with Spoiler	Hatch	1983-87	2	D4400
with Spoiler & Louvers	Hatch	1983-87	2	D4688
without Spoiler	Hatch	1983-87	2	D4618
Colt				
Left	Hatch	1989-95	1	C4961L
Right	Hatch	1989-95	1	C4961R
Wagon; 4-Door	Hatch	1984-91	2	B4733
Left	Hatch	1985-88	1	B4737
Right	Hatch	1985-88	1	B4742
	Hatch	1979-83	2	C4713
D150				
Front Right	Seat Adjustment Strut	1990-93	1	D4796
D250				
Front Right	Seat Adjustment Strut	1990-93	1	D4796
D350				
Front Right	Seat Adjustment Strut	1990-93	1	D4796
Dakota				
	Hood	2004-12	2	D6312
Daytona				
	Hatch	1984-93	2	C4712

GAS CHARGED LIFT SUPPORTS ARE DESIGNED TO BE USED EXCLUSIVELY FOR THE PURPOSE SPECIFIED IN APPLICATION CHARTS. Tech Support 1-888-565-9632

APPLICATION GUIDE / GUÍA DE APLICACIONES / GUIDE D'APPLICATIONS



MAKE & MODEL	LOCATION	YEAR	QTY	PART
Dodge (cont.)				
Diplomat				
Wagon; 4-Door; Eyelets on Both Ends; without Wiper	Tailgate	1978-81	2	D4409
Durango				
Except Power Liftgate with Power Lift Gate	Hood	2011-22	2	C6485
	Liftgate	2011-16	2	C7061
	Hatch	2011-13	1	C6469
	Liftgate	2006-09	2	C4396
	Liftgate	2004-05	2	C6181
SXT	Liftgate	2003	2	C4290
Sport	Liftgate	2002-03	2	C4290
R/T	Liftgate	2000-03	2	C4290
SLT	Liftgate	1998-03	2	C4290
SLT Plus	Liftgate	1998-03	2	C4290
	Truck Bed Storage Box Lid	1998-03	2	F6904
Base	Liftgate	1998-01	2	C4290
Sport	Liftgate	2000	2	C4290
Grand Caravan				
without Power Lift Gate	Liftgate	2008-19	2	C6257
with Power Lift Gate	Liftgate, Gas Charged	2008-17	2	C6124
SE	Seat Adjustment Strut	2005-07	2	F4096
SXT	Seat Adjustment Strut	2005-07	2	F4096
	Liftgate	2001-07	2	C4535
	Hatch	1996-00	2	B4865
with Wiper	Liftgate	1991-95	2	C4837
without Stereo; without Wiper	Liftgate	1991-95	2	C4834
i10				
MEX	Hatch	2012-14	2	D6739
Intrepid				
	Hood	1998-04	2	C4257
	Trunk Lid	1998-04	2	E4958
	Hood	1993-97	2	E4468
Journey				
	Hatch	2009-20	2	D6451
Lancer				
	Hatch	1985-89	2	D4436
Magnum				
	Hood	2005-08	2	E6303
Wagon; 4-Door	Tailgate	2005-08	2	D6103
Monaco				
	Hood	1990-92	2	D4613
Nitro				
	Hatch	2007-12	2	D6178
Omni				
with Spoiler	Hatch	1982	2	D4400
024; with Spoiler & Louvers	Hatch	1980-82	2	D4688

MAKE & MODEL	LOCATION	YEAR	QTY	PART
Dodge (cont.)				
Omni (cont.)				
without Spoiler	Hatch	1980-82	2	D4618
with Spoiler	Hatch	1978-80	2	D4400
Ram 1500				
	Hood	2009-10	2	D6659
	Hood	2002-08	2	D4364
	Seat Adjustment Strut	2002-07	1	F7148
Ram 2500				
	Hood	2010	1	D7018
	Hood	2002-09	2	D4364
	Seat Adjustment Strut	2003-07	1	F7148
Ram 3500				
Cab & Chassis	Hood	2010	1	D4364
Crew Cab Pickup	Hood	2010	1	D7018
Extended Crew Cab Pickup	Hood	2010	1	D7018
Standard Cab Pickup	Hood	2010	1	D7018
	Hood	2002-09	2	D4364
	Seat Adjustment Strut	2003-07	1	F7148
Ram 4500				
	Hood	2008-10	2	D4364
Ram 5500				
	Hood	2008-10	2	D4364
Ramcharger				
	Hatch	1991-93	2	C4772
Front Right	Seat Adjustment Strut	1988-93	1	D4796
	Hatch	1981-90	2	C4715
	Hatch	1974-80	2	E4441
Shadow				
with Spoiler	Hatch	1987-94	2	D4449
without Spoiler	Hatch	1987-94	2	D4490
St. Regis				
Hardtop; 4-Door	Hatch	1979	2	D4442
Stealth				
without Rear Wiper	Hatch	1991-96	2	A4982
Left	Hood	1991-96	1	D4523L
Right	Hood	1991-96	1	D4523R
Stratus				
with Spoiler	Trunk Lid	2001-06	2	E4045
without Spoiler	Trunk Lid	2001-06	2	E4064
	Trunk Lid	1995-00	2	E4477
Viper				
with Spoiler	Hatch	2008-10	2	E6015
Convertible; 2-Door; SRT-10	Trunk Lid	2008-10	2	D6406
Coupe; 2-Door; SRT-10	Trunk Lid	2008-10	2	D6406
Coupe; 2-Door; SRT-10 ACR	Trunk Lid	2008-10	2	D6406

GAS CHARGED LIFT SUPPORTS ARE DESIGNED TO BE USED EXCLUSIVELY FOR THE PURPOSE SPECIFIED IN APPLICATION CHARTS. Tech Support 1-888-565-9632

MAKE & MODEL	LOCATION	YEAR	QTY	PART
Dodge (cont.)				
Viper (cont.)				
with Spoiler	Hatch	2006	2	E6015
Coupe; 2-Door; SRT-10	Trunk Lid	2006	2	D6406
SRT-10	Hood	2003-06	2	E4178
Convertible; 2-Door; SRT-10	Trunk Lid	2003-06	2	D6406
Coupe	Hatch	1996-02	2	C4250
W150				
Front Right	Seat Adjustment Strut	1990-93	1	D4796
W250				
Front Right	Seat Adjustment Strut	1990-93	1	D4796
W350				
Front Right	Seat Adjustment Strut	1990-93	1	D4796
Eagle				
Premier				
	Hood	1988-92	2	D4613
Summit				
Left	Hatch	1989-94	1	C4961L
Right	Hatch	1989-94	1	C4961R
Talon				
Left	Hatch	1995-98	1	A4952L
Right	Hatch	1995-98	1	A4952R
	Hatch	1990-94	2	C4731
Vision				
	Hood	1993-97	2	E4468
Ferrari				
328 GTB				
Front	Trunk Lid	1985-89	2	E6363
328 GTS				
Front	Trunk Lid	1985-89	2	E6363
348 GTB				
	Trunk Lid	1993-94	2	F6366
348 GTS				
	Trunk Lid	1993-94	2	F6366
348 Spider				
Convertible; 2-Door	Trunk Lid	1993-95	2	F6366
348 TB				
	Trunk Lid	1990-92	2	F6366
348 TS				
	Trunk Lid	1989-92	2	F6366
512 TR				
	Hood	1992-94	2	F6280
Mondial				
	Hood	1983-85	2	F6531
Rear	Trunk Lid	1983-85	2	F6441
Mondial 3.2				
	Hood	1986-88	2	F6531
Rear	Trunk Lid	1986-88	2	F6441

MAKE & MODEL	LOCATION	YEAR	QTY	PART
Ferrari (cont.)				
Mondial 8				
	Hood	1980-85	2	F6531
Rear	Trunk Lid	1980-85	2	F6441
Mondial t				
	Hood	1989-93	2	F6531
Rear	Trunk Lid	1989-93	2	F6441
Testarossa				
	Hood	1985-91	2	F6280
Fiat				
500				
	Hatch	2012-19	2	D6667
Palio				
MEX	Hatch	2007-08	2	D6744
MEX	Hatch	2004-06	2	D6743
Ford				
Aerostar				
with Wiper	Liftgate	1988-97	2	C4781
without Rear Wiper	Liftgate	1988-93	2	C4271
From 05/1987; with Wiper	Liftgate	1987	2	C4781
From 05/1987; without Rear Wiper	Liftgate	1987	2	C4271
To 05/1987; without Rear Wiper	Liftgate	1987	2	C4273
To 05/1987; with Wiper	Hatch	1986-87	2	C4784
without Rear Wiper	Liftgate	1986	2	C4273
Aspire				
Left	Hatch	1994-97	1	C4319L
Right	Hatch	1994-97	1	C4319R
Bronco II				
with Movable Rear Window	Back Glass	1984-90	2	D4423
	Hatch	1984-90	2	D4600
Contour				
with Spoiler	Trunk Lid	1995-00	2	E4475
without Spoiler	Trunk Lid	1995-00	2	E4506
Crown Victoria				
	Hood	1998-11	2	E4550
	Hood	1992-97	2	E4467
EcoSport				
	Hatch	2013-21	2	D6745
MEX	Hatch	2004-12	2	D6542
Edge				
	Hatch	2007-14	2	C6120
Escape				
Left; without Power Lift Gate	Tailgate	2013-17	1	B6686
Right; without Power Lift Gate	Tailgate	2013-17	1	B6687
	Back Glass	2008-12	2	D6260
	Hatch	2001-12	2	C4370
	Back Glass	2001-07	2	C4369

GAS CHARGED LIFT SUPPORTS ARE DESIGNED TO BE USED EXCLUSIVELY FOR THE PURPOSE SPECIFIED IN APPLICATION CHARTS. Tech Support 1-888-565-9632

APPLICATION GUIDE / GUÍA DE APLICACIONES / GUIDE D'APPLICATIONS



MAKE & MODEL	LOCATION	YEAR	QTY	PART
Ford (cont.)				
Escort				
Left	Deck Lid	1998-03	1	C4322L
Right	Deck Lid	1998-03	1	C4322R
Wagon; 4-Door	Tailgate	1997-99	2	D4538
without Rear Wiper	Hatch	1991-99	2	B4896
Left; without Spoiler	Hatch	1991-97	1	B4840
Right; without Spoiler	Hatch	1991-97	1	B4839
Wagon; 4-Door; without Rear Wiper	Tailgate	1993-96	2	D4649
Wagon; 4-Door	Tailgate	1991-92	2	D4681
with Rear Defroster	Hatch	1981-90	2	C4722
without Rear Defroster	Hatch	1981-90	2	C4732
Excursion				
4WD	Back Glass	2000-05	2	E6600
RWD	Back Glass	2000-05	2	E4139
	Hood	2000-05	2	D4339
EXP				
	Hatch	1986-88	2	D4610
	Hatch	1982-85	2	D4415
Expedition				
From 03/30/2009	Hood	2008-17	2	E6647
	Back Glass	2007-17	2	D6253
	Hatch	2003-17	2	C6100
To 03/30/2009	Hood	2007-09	2	E7078
	Back Glass	2003-06	2	D4191
Original Hood	Hood	1997-06	2	E4478
with Steel Hood	Hood	1997-06	2	E4578
	Back Glass	1997-02	2	D4676
	Liftgate	1997-02	2	C4964
Explorer				
without Power Lift Gate	Hatch	2011-15	2	C6681
	Back Glass	2006-10	2	D6615
	Hatch	2006-10	2	C6139
	Hood	2002-10	2	E4142
	Back Glass	2005	2	D6624
	Liftgate	2002-05	2	C4584
From 07/2002	Back Glass	2004	2	D6609
From 03/04/2002; To 05/05/2003	Back Glass	2002-03	2	D4372
	Hood	1995-01	2	F4026
	Back Glass	1991-01	2	D4608
	Hatch	1991-01	2	C4754
Explorer Sport				
	Hatch	2001-03	2	C4754
	Hood	2001-03	2	F4067
To 03/04/2002	Back Glass	2001-02	2	D4608
Explorer Sport Trac				
	Hood	2007-10	2	E4142

MAKE & MODEL	LOCATION	YEAR	QTY	PART
Ford (cont.)				
Explorer Sport Trac (cont.)				
	Hood	2001-05	2	F4067
F-150				
Left	Hood	2015-20	1	E6861
Right	Hood	2015-20	1	E6862
	Hood	2009-14	2	E6484
	Hood	2005-08	2	D4153
with Steel Hood	Hood	1997-04	2	E4578
Original Hood	Hood	1995-04	2	E4478
F-150 Heritage				
	Hood	2004	2	E4478
F-250				
with Steel Hood	Hood	1997-99	2	E4578
Original Hood	Hood	1995-99	2	E4478
F-250 HD				
Original Hood	Hood	1997	2	E4478
F-250 Super Duty				
Left	Hood	2011-16	1	C6196
Right	Hood	2011-16	1	C6646
	Hood	2008-10	2	C6767
	Hood	1999-07	2	D4339
F-350 Super Duty				
Left	Hood	2011-16	1	C6196
Right	Hood	2011-16	1	C6646
	Hood	2008-10	2	C6767
	Hood	1999-07	2	D4339
F-450 Super Duty				
Left	Hood	2011-16	1	C6196
Right	Hood	2011-16	1	C6646
	Hood	2008-10	2	C6767
	Hood	1999-07	2	D4339
F-550 Super Duty				
Left	Hood	2011-16	1	C6196
Right	Hood	2011-16	1	C6646
	Hood	2008-10	2	C6767
	Hood	1999-07	2	D4339
Fairmont				
Wagon; 4-Door	Tailgate	1978-83	2	D4408
	Back Glass	1978-81	2	D4405
Festiva				
	Hatch	1988-93	2	B4831
Fiesta				
	Hatch	2011-19	2	C6791
Sedan; 4-Door; MEX	Trunk Lid	2005-08	2	F6540
Hatchback; MEX	Hatch	2003-08	2	C6541
Sedan; 4-Door; MEX	Trunk Lid	2003	2	F6540
MEX	Hatch	1998-01	2	C6546
	Hatch	1978-80	2	C4716

GAS CHARGED LIFT SUPPORTS ARE DESIGNED TO BE USED EXCLUSIVELY FOR THE PURPOSE SPECIFIED IN APPLICATION CHARTS. Tech Support 1-888-565-9632

MAKE & MODEL	LOCATION	YEAR	QTY	PART
Ford (cont.)				
Five Hundred				
	Trunk Lid	2005-07	2	E4074
Flex				
	Hood	2009-19	2	C6553
with Power Lift Gate	Liftgate, Gas Charged	2009-16	2	C6246
without Power Lift Gate	Liftgate	2009-12	2	C6670
Focus				
	Hatch	2012-18	2	C7034
Sedan; 4-Door	Trunk Lid	2012-18	2	D6013
without Spoiler	Trunk Lid	2003-11	2	E6436
Hatchback; 2-Door; CAN	Hatch	2003-07	2	D6502
Hatchback; 2-Door; USA	Hatch	2003-07	2	D6502
Hatchback; 4-Door; CAN	Hatch	2003-07	2	D6502
Hatchback; 4-Door; USA	Hatch	2003-07	2	D6502
Wagon	Tailgate	2000-07	2	D4358
LX; with Spoiler	Trunk Lid	2000-04	2	E4130
SE; with Spoiler	Trunk Lid	2000-04	2	E4130
ZTS; with Spoiler	Trunk Lid	2000-04	2	E4130
SE; without Spoiler	Trunk Lid	2002	2	E6436
ZTS; without Spoiler	Trunk Lid	2002	2	E6436
Hatchback; 2-Door	Hatch	2000-02	2	D4357
Sony Limited Edition	Hatch	2000	1	D4357
LX; without Spoiler	Trunk Lid	2000	2	E6436
SE; without Spoiler	Trunk Lid	2000	2	E6436
Sony Limited Edition; without Spoiler	Trunk Lid	2000	2	E6436
ZTS; without Spoiler	Trunk Lid	2000	2	E6436
Freestar				
with Power Lift Gate	Liftgate, Gas Charged	2004-07	2	C6447
without Power Lift Gate	Liftgate	2004-07	2	C4593
Freestyle				
From 12/2005	Tailgate	2006-07	2	C6199
To 12/2005	Tailgate	2005-06	2	D6453
Fusion				
with Spoiler	Trunk Lid	2010-12	2	E6675
From 07/16/2007; with Spoiler	Trunk Lid	2007-09	2	E6393
To 07.17.2007; without Spoiler	Trunk Lid	2007	2	E4075
From 08/30/2006; To 07/16/2007; with Spoiler	Trunk Lid	2006-07	2	E6671
without Spoiler	Trunk Lid	2006	1	E4075
Granada				
Wagon; 4-Door	Back Glass	1982	2	C4720
Wagon; 4-Door	Tailgate	1982	2	D4408
GT				
	Trunk Lid	2005-06	2	E4075
Ka				
MEX	Hatch	2001-08	2	D6543

MAKE & MODEL	LOCATION	YEAR	QTY	PART
Ford (cont.)				
Lobo				
Left	Hood	2015-20	1	E6861
Right	Hood	2015-20	1	E6862
LTD				
Wagon; 4-Door	Back Glass	1983-86	2	C4720
Wagon; 4-Door	Tailgate	1983-86	2	D4408
	Back Glass	1982	2	D4405
Mondeo				
MEX	Hood	2001-07	2	F6545
MEX	Trunk Lid	2001-07	2	E6544
Mustang				
Convertible; 2-Door; without Spoiler	Deck Lid	2015-20	2	E7129
with Spoiler	Trunk Lid	2005-14	2	E6408
without Spoiler	Trunk Lid	2005-14	2	E6457
with Spoiler	Trunk Lid	1994-04	2	D6803
without Spoiler	Trunk Lid	1994-04	2	D4643
with Spoiler	Hatch	1979-93	2	D4686
without Spoiler	Hatch	1979-93	2	D4408
Mustang II				
with Spoiler	Hatch	1977-78	2	D4401
without Spoiler	Hatch	1977-78	2	D4403
	Hatch	1974-76	2	D4602
Pinto				
	Back Glass	1974-80	2	D4405
Police Interceptor Sedan				
	Hood	2013-19	2	D6560
with Spoiler	Trunk Lid	2013-19	2	E6559
without Spoiler	Trunk Lid	2013-19	2	E6549
Police Interceptor Utility				
without Power Lift Gate	Hatch	2013-15	1	C6681
Police Responder Hybrid				
	Hood	2019	2	D6560
Probe				
Left; with Spoiler	Hatch	1993-97	1	D4859
Left; without Spoiler	Hatch	1993-97	1	D4842
Right; with Spoiler	Hatch	1993-97	1	D4858
Right; without Spoiler	Hatch	1993-97	1	D4841
Left; with Spoiler; with Wiper	Hatch	1989-92	1	C4833
Left; without Spoiler; without Wiper	Hatch	1989-92	1	C4836
Right; with Spoiler; with Wiper	Hatch	1989-92	1	C4832
Right; without Spoiler; without Wiper	Hatch	1989-92	1	C4835
Special Service Police Sedan				
	Hood	2015-18	2	D6560
with Spoiler	Trunk Lid	2015-18	2	E6559
without Spoiler	Trunk Lid	2015-18	2	E6549

GAS CHARGED LIFT SUPPORTS ARE DESIGNED TO BE USED EXCLUSIVELY FOR THE PURPOSE SPECIFIED IN APPLICATION CHARTS. Tech Support 1-888-565-9632

APPLICATION GUIDE / GUÍA DE APLICACIONES / GUIDE D'APPLICATIONS



MAKE & MODEL	LOCATION	YEAR	QTY	PART
Ford (cont.)				
SSV Plug-In Hybrid				
	Hood	2019	2	D6560
Taurus				
	Hood	2010-19	2	D6560
with Spoiler	Trunk Lid	2010-19	2	E6559
without Spoiler	Trunk Lid	2010-19	2	E6549
From 04/30/2007	Hood	2007-09	2	D6753
	Trunk Lid	2007-09	2	E4074
	Hood	2000-06	2	C4368
Wagon; 4-Door	Back Glass	1996-05	2	D4646
Wagon; 4-Door	Tailgate	1996-05	2	C4205
	Hood	1996-99	2	C4204
Wagon; 4-Door	Back Glass	1986-95	2	D4440
without Hood Light	Hood	1986-95	2	D4439
Wagon; 4-Door	Tailgate	1986-95	2	D4601
with Hood Light	Hood	1986-91	2	D4214
Taurus X				
	Tailgate	2008-09	2	C6199
Thunderbird				
Convertible; 2-Door	Deck Lid	2002-05	2	E4073
	Hood	2002-05	2	D4154
	Hood	1989-97	2	D4462
Windstar				
	Liftgate	1999-03	2	C4559
To 12/09/1996	Hatch	1995-97	2	C4203
Geo				
Metro				
Left	Hatch	1995-97	1	B4987L
Right	Hatch	1995-97	1	B4987R
Left	Hatch	1989-94	1	C4827
Right	Hatch	1989-94	1	C4826
Convertible; 2-Door; LSi	Deck Lid	1990-93	2	B4919
Prizm				
	Hatch	1989-92	2	C4908
Storm				
	Hatch	1993	2	D4622
2+2	Hatch	1990-92	2	D4623
2+2 GSi	Hatch	1990-92	2	D4620
Base	Hatch	1990-92	2	D4623
Tracker				
Rear	Door	1990-97	1	C4789
GMC				
Acadia				
	Hood	2013-17	2	B6766
	Liftgate	2007-16	2	C6152
	Hood	2007-12	1	C6153
Acadia Limited				
	Hood	2017	2	B6766

MAKE & MODEL	LOCATION	YEAR	QTY	PART
GMC (cont.)				
C1500 Suburban				
2nd Design; with Rear Defroster	Back Glass	1994-99	2	D4184
without Rear Defroster	Back Glass	1994-99	2	D4650
C2500 Suburban				
2nd Design; with Rear Defroster	Back Glass	1994-99	2	D4184
without Rear Defroster	Back Glass	1994-99	2	D4650
Envoy				
	Back Glass	2002-09	2	C4576
	Hatch	2002-09	2	C4573
Envoy XL				
Denali; 129.0" WB	Back Glass	2005-06	2	D4575
Denali; 129.0" WB	Liftgate	2005-06	2	C4574
SLE; 129.0" WB	Back Glass	2002-06	2	D4575
SLT; 129.0" WB	Back Glass	2002-06	2	D4575
SLE; 129.0" WB	Liftgate	2002-06	2	C4574
SLT; 129.0" WB	Liftgate	2002-06	2	C4574
Envoy XUV				
129.0" WB	Back Glass	2004-05	2	D4575
129.0" WB	Liftgate	2004-05	2	C4574
Jimmy				
4-Door; with Liftgate; with Steel Liftgate	Hatch	2000-01	2	C4287
with Aluminum Liftgate	Liftgate	2000-01	2	C6101
4-Door; with Liftgate	Back Glass	1997-01	2	C4799
2-Door; with Droppgate	Back Glass	1995-01	2	D4642
4-Door; with Droppgate	Back Glass	1995-01	2	D4316
with Droppgate	Tailgate	1995-01	2	F4531
4-Door; with Liftgate	Hatch	1997-99	2	C4287
with Rear Defroster	Back Glass	1983-94	2	D4451
without Rear Defroster	Back Glass	1983-94	2	D4404
S15 Jimmy				
with Rear Defroster	Back Glass	1983-91	2	D4451
without Rear Defroster	Back Glass	1983-91	2	D4404
Safari				
	Back Glass	2001-05	2	C6610
	Back Glass	1992-00	2	C4219
Savana 1500				
	Cargo Van Access Panel	2003-14	2	C6900
Rear	Door	2003-14	2	D6901
Savana 2500				
	Cargo Van Access Panel	2003-19	2	C6900
Rear	Door	2003-19	2	D6901
Savana 3500				
	Cargo Van Access Panel	2003-19	2	C6900
Rear	Door	2003-19	2	D6901

GAS CHARGED LIFT SUPPORTS ARE DESIGNED TO BE USED EXCLUSIVELY FOR THE PURPOSE SPECIFIED IN APPLICATION CHARTS. Tech Support 1-888-565-9632

MAKE & MODEL	LOCATION	YEAR	QTY	PART	
GMC (cont.)					
Savana 4500					
Rear; Cutaway	Door	2017-19	2	D6901	
Terrain					
without Power Lift Gate	Liftgate	2010-17	1	C6809	
with Power Lift Gate	Liftgate, Gas Charged	2010-15	1	C6764	
Yukon					
2nd Design	Back Glass	2015-20	2	D6869	
	Back Glass	2007-14	2	D6157	
	Hatch	2007-14	2	C6156	
	Hood	2007-14	2	C6155	
	Hatch	2005-06	2	C6151	
	Back Glass	2000-06	2	D4185	
	Liftgate	1994-04	2	C4557	
	2nd Design; with Rear Defroster	Back Glass	1994-99	2	D4184
	without Rear Defroster	Back Glass	1994-99	2	D4650
	1st Design; with Rear Defroster	Back Glass	1994	2	D4190
with Rear Defroster	Back Glass	1992-93	2	D4190	
Yukon XL					
	Back Glass	2015-20	2	D6869	
Yukon XL 1500					
2nd Design	Back Glass	2007-14	2	D6157	
	Hatch	2007-14	2	C6156	
	Hood	2007-14	2	C6155	
	Hatch	2005-06	2	C6151	
	Back Glass	2000-06	2	D4185	
1st Design	Liftgate	2000-04	2	C4557	
Yukon XL 2500					
2nd Design	Back Glass	2007-13	2	D6157	
	Hatch	2007-13	2	C6156	
	Hood	2007-13	2	C6155	
	Hatch	2005-06	2	C6151	
	Back Glass	2000-06	2	D4185	
1st Design	Liftgate	2000-04	2	C4557	
Honda					
Accord					
V6 2.7L 2675cc Left; Wagon; 5-Door Right; Wagon; 5-Door Left; Wagon; 5-Door Right; Wagon; 5-Door Hatchback	Hood	2013-16	2	D7090	
	Hood	2008-12	1	D6175	
	Hood	2003-07	2	D4157	
	Hood	1998-02	2	D4352	
	Hood	1995-97	2	D4656	
	Tailgate	1994-97	1	C4869L	
	Tailgate	1994-97	1	C4869R	
	Trunk Lid	1994-96	2	E4679	
	Hatch	1991-93	1	C4868L	
	Hatch	1991-93	1	C4868R	
Hatch	1986-89	2	C4811		

MAKE & MODEL	LOCATION	YEAR	QTY	PART
Honda (cont.)				
Accord (cont.)				
S	Hatch	1985	2	C4714
SEi	Hatch	1985	2	C4714
Base	Hatch	1984-85	2	C4714
LX	Hatch	1984-85	2	C4714
	Hatch	1982-83	2	D4437
	Hatch	1976-81	2	D4432
Accord Crosstour				
	Hatch	2010-11	2	D6770
	Hood	2010-11	2	D6769
Civic				
EP3 Body; Si	Hatch	2002-05	2	C6501
Left; CX	Hatch	1996-00	1	C4870L
Left; DX	Hatch	1996-00	1	C4870L
Right; CX	Hatch	1996-00	1	C4870R
Right; DX	Hatch	1996-00	1	C4870R
Sedan; 4-Door	Trunk Lid	1992-96	2	E4679
	Hatch	1992-95	2	D4648
Wagon; 4-Door; DX	Hatch	1991	2	C4909
Hatchback; 2-Door; Si	Hatch	1989-91	2	C4812
Hatchback; 2-Door; Base	Hatch	1988-91	2	C4812
Hatchback; 2-Door; DX	Hatch	1988-91	2	C4812
Wagon; 4-Door; RT 4WD	Hatch	1988-91	2	C4909
Wagon; 4-Door; Base	Hatch	1988-90	2	C4909
Wagon; 4-Door; Wagon	Hatch	1988-89	2	C4909
CRX HF	Hatch	1987	2	B4817
CRX Si	Hatch	1985-87	2	B4817
CRX	Hatch	1984-87	2	B4817
Sedan; Base	Hatch	1984-87	2	C4810
Wagon; 4-Door	Tailgate	1984-87	2	C4222
	Hatch	1982-83	2	B4736
Wagon	Tailgate	1980-83	2	C4757
	Hatch	1981	2	B4738
	Hatch	1980	1	B4740
	Hatch	1973-79	2	D4435
Civic del Sol				
	Trunk Lid	1993-97	2	E4502
Crosstour				
	Hatch	2012-15	2	D6770
	Hood	2012-15	2	D6769
CR-V				
From 2003; Japan Built; To 2004	Hatch	2012-16	2	C6665
	Liftgate	2007-11	2	C6179
	Back Glass	2002-06	2	E6604
	Door	2002-06	1	C6213
	Back Glass	1997-01	2	C4294

GAS CHARGED LIFT SUPPORTS ARE DESIGNED TO BE USED EXCLUSIVELY FOR THE PURPOSE SPECIFIED IN APPLICATION CHARTS. Tech Support 1-888-565-9632

APPLICATION GUIDE / GUÍA DE APLICACIONES / GUIDE D'APPLICATIONS



MAKE & MODEL	LOCATION	YEAR	QTY	PART
Honda (cont.)				
CR-V (cont.)				
Rear	Door	1997-01	1	D6150
CRX				
	Hatch	1988-91	2	C4611
Element				
	Hatch	2003-11	2	C4585
Fit				
	Hatch	2009-14	2	D6746
	Hatch	2006-08	2	D6773
HR-V				
	Hatch	2016-18	1	C7178
Insight				
	Hatch	2010-14	2	D7179
	Hatch	2000-06	2	C6239
Odyssey				
Except Power Lift Gate	Hatch	2011-17	2	C7091
with Power Lift Gate	Hatch	2011-17	2	C7075
with Power Lift Gate	Hatch	2005-10	2	B6238
without Power Lift Gate	Hatch	2005-10	2	B6117
	Hatch	2003-04	2	C6111
	Hatch	1999-02	2	B4558
Left	Liftgate	1995-98	1	C4283L
Right	Liftgate	1995-98	1	C4283R
Passport				
	Back Glass	1994-02	2	D4644
Pilot				
	Back Glass	2009-15	2	D6649
with Power Lift Gate	Liftgate, Gas Charged	2009-15	2	D6648
without Power Lift Gate	Liftgate	2009-15	2	D6663
	Liftgate	2008	2	C6008
	Hatch	2003-07	2	C4373
Hummer				
H2				
	Liftgate	2003-09	2	C6503
H3				
Rear	Door	2006-10	1	C6289
	Hood	2006-10	2	E6288
H3T				
	Hood	2009-10	2	E6288
Hyundai				
Accent				
	Hatch	2012-17	2	D6778
	Trunk Lid	2007-11	2	C7134
with Rear Wiper	Hatch	2003-05	2	C6516
From 04/19/1995	Hatch	1995-99	2	C4292
Azera				
	Deck Lid	2006-11	2	D7044
	Hood	2006-11	1	B6240

MAKE & MODEL	LOCATION	YEAR	QTY	PART
Hyundai (cont.)				
Elantra				
	Hatch	2009-12	2	D7048
Hatchback	Hatch	2001-06	2	D6518
Left; Wagon; 5-Door	Tailgate	1996-00	1	D4324L
Right; Wagon; 5-Door	Tailgate	1996-00	1	D4324R
Elantra GT				
	Hatch	2013-17	2	C6799
Entourage				
with Power Lift Gate	Hatch	2007-08	2	C7004
	Hood	2007-08	2	E6326
without Power Lift Gate	Liftgate	2007-08	2	C6118
Equus				
	Hood	2011-16	2	C6873
Excel				
Right	Hatch	1993-94	1	B4303R
Left	Hatch	1990-94	1	B4303L
	Hatch	1986-89	2	C4725
Genesis				
To 11/13/2015	Hood	2014-16	2	E7019
To 08/02/2012	Hood	2009-13	1	C6673
Genesis Coupe				
	Hood	2010-16	1	B6454
Santa Fe				
	Hood	2013-19	2	E6877
	Hood	2007-12	2	D6682
Except Sub Woofer	Liftgate	2007-12	2	D6683
	Back Glass	2001-06	2	D4192
	Hood	2001-06	2	D4175
	Liftgate	2001-06	2	C6109
Santa Fe Sport				
without Power Lift Gate	Liftgate	2016-18	2	C7017
	Hood	2013-18	2	E6877
From 01/01/2015; without Power Lift Gate	Liftgate	2015	2	C7017
To 01/01/2015	Liftgate	2015	1	D6878
	Liftgate	2013-14	2	D6878
Santa Fe XL				
Korean Built	Hood	2019	2	E6877
Sonata				
	Hood	2015-17	2	E6020
	Hood	2011-14	2	E6489
	Hood	2006-10	1	B6336
	Trunk Lid	2006-10	2	E6428
	Hood	2002-05	2	D4383
	Trunk Lid	2002-05	2	E4145
Tiburon				
with Spoiler	Hatch	2003-08	2	C6248
without Spoiler	Hatch	2003-08	2	C4587
	Hood	2003-08	2	D6352

GAS CHARGED LIFT SUPPORTS ARE DESIGNED TO BE USED EXCLUSIVELY FOR THE PURPOSE SPECIFIED IN APPLICATION CHARTS. Tech Support 1-888-565-9632

MAKE & MODEL	LOCATION	YEAR	QTY	PART
Hyundai (cont.)				
Tiburon (cont.)				
	Hatch	2000-01	2	A6523
with Spoiler	Hatch	1997-99	2	A4985
Tucson				
	Liftgate	2016-21	2	C6450
To 10/22/2015	Liftgate	2010-16	2	D6883
	Back Glass	2005-09	2	E6611
	Hatch	2005-09	2	D6129
Veloster				
without Rear Wiper	Hatch	2012-16	2	E6734
Veracruz				
	Hood	2007-12	2	D6184
with Power Lift Gate	Liftgate, Gas Charged	2007-12	2	C7045
Except Power Liftgate	Hatch	2007-09	2	C6185
XG300				
	Hood	2001	2	D6320
XG350				
	Hood	2002-05	2	D6320
	Trunk Lid	2002-05	2	E6287
INFINITI				
EX35				
	Hood	2008-12	2	E6473
EX37				
	Hood	2013	2	E6473
FX35				
S51 Body	Hood	2009-12	2	E6374
	Hatch	2008-12	2	D6375
	Hood	2003-08	2	E6365
FX37				
S51 Body	Hood	2013	2	E6374
FX45				
	Hood	2003-08	2	E6365
FX50				
S51 Body	Hatch	2009-13	2	D6375
S51 Body	Hood	2009-13	2	E6374
G20				
	Trunk Lid	1999-02	2	E6418
	Trunk Lid	1991-94	2	E4028
G25				
	Hood	2011-12	1	E6296
G35				
	Hood	2008	1	E6296
with Spoiler	Trunk Lid	2003-08	2	E6419
G37				
IPL; with Spoiler	Deck Lid	2013	2	F6839
Journey; with Spoiler	Deck Lid	2013	2	F6839
Sport; with Spoiler	Deck Lid	2013	2	F6839
X; with Spoiler	Deck Lid	2013	2	F6839
Sedan	Hood	2010-13	2	E6296

MAKE & MODEL	LOCATION	YEAR	QTY	PART
INFINITI (cont.)				
G37 (cont.)				
Sedan	Trunk Lid	2009-13	2	F6297
Coupe	Hood	2008-13	2	E6471
Coupe; with Spoiler	Deck Lid	2011-12	2	F6839
Coupe; 2-Door	Trunk Lid	2008-11	2	F6472
I30				
	Hood	2000-01	2	D6313
	Hood	1996-99	2	E4524
I35				
	Hood	2002-04	2	D6313
J30				
	Hood	1993-97	2	D4692
JX35				
	Hood	2013	2	E6847
M35				
	Hood	2006-10	2	E6771
	Trunk Lid	2006-10	2	E6772
M35h				
with Spoiler	Trunk Lid	2012-13	2	E6022
without Spoiler	Trunk Lid	2012-13	2	E7001
M37				
	Hood	2011-13	2	E6021
with Spoiler	Trunk Lid	2011-13	2	E6022
without Spoiler	Trunk Lid	2011-13	2	E7001
M45				
	Hood	2007-10	2	E6771
	Trunk Lid	2006-10	2	E6772
	Hood	2006	2	D6455
	Hood	2003-04	2	D6455
	Trunk Lid	2003-04	2	E6695
M56				
	Hood	2011-13	2	E6021
with Spoiler	Trunk Lid	2011-13	2	E6022
without Spoiler	Trunk Lid	2011-13	2	E7001
Q40				
	Hood	2015	1	E6296
Q45				
	Hood	2005-06	1	E6850
	Hood	2002-04	2	D6879
	Hood	1997-01	2	D6317
	Hood	1990-96	2	C4201
Q50				
2nd Design	Hood	2014-21	2	E7086
	Trunk Lid	2014-21	2	E6802
1st Design; From 11/2014	Hood	2014-19	2	C6801
Q60				
Coupe; 2-Door	Deck Lid	2014-15	2	F6839
	Hood	2014-15	1	E6471

GAS CHARGED LIFT SUPPORTS ARE DESIGNED TO BE USED EXCLUSIVELY FOR THE PURPOSE SPECIFIED IN APPLICATION CHARTS. Tech Support 1-888-565-9632

APPLICATION GUIDE / GUÍA DE APLICACIONES / GUIDE D'APPLICATIONS



MAKE & MODEL	LOCATION	YEAR	QTY	PART
INFINITI (cont.)				
Q70				
	Hood	2014-19	2	E6021
Q70L				
	Hood	2015-19	2	E6021
QX4				
From 12/1998	Back Glass	1999-03	2	D6192
To 09/1999	Hatch	1997-00	2	C4321
To 12/1998	Back Glass	1997-99	2	D4320
QX50				
	Hood	2014-17	2	E6473
QX56				
with Power Lift Gate	Hood	2011-13	2	D6016
	Liftgate, Gas Charged	2011-13	2	D7022
	Back Glass	2004-10	2	D6612
	Hood	2004-10	2	E6149
	Liftgate	2004-10	1	C6445
QX60				
	Hood	2014-20	2	E6847
QX70				
S51 Body	Hood	2014-17	2	E6374
QX80				
To 10/2017	Liftgate	2018	2	D7022
To 10/2017	Hood	2014-18	2	D6016
with Power Lift Gate	Liftgate, Gas Charged	2014-17	2	D7022
International				
Scout				
	Hatch	1971	2	B4719
Isuzu				
Amigo				
	Back Glass	1999-00	2	D4644
Ascender				
	Back Glass	2008	2	C4576
113.0" WB	Hatch	2004-08	2	C4573
113.0" WB	Back Glass	2004-06	1	D4575
129.0" WB	Back Glass	2004-06	1	D4575
129.0" WB	Liftgate	2003-06	2	C4574
129.0" WB	Back Glass	2003	2	D4575
I-Mark				
	Hatch	1985-89	2	C4452
Impulse				
without Ball Type End Fittings	Hatch	1990-92	2	D4620
Left; From 03/1985	Hatch	1985-89	1	E4819
Right; From 03/1985	Hatch	1985-89	1	E4820
	Hood	1983-87	2	D4752
Oasis				
Left	Liftgate	1996-99	1	C4283L
Right	Liftgate	1996-99	1	C4283R
Rodeo				
	Back Glass	1991-04	2	D4644

MAKE & MODEL	LOCATION	YEAR	QTY	PART
Isuzu (cont.)				
Rodeo Sport				
	Back Glass	2001-03	2	D4644
Jaguar				
S-Type				
	Hood	2000-08	2	D6350
Vanden Plas				
	Deck Lid	1995-03	2	E6922
	Hood	1995-03	2	D4385
	Hood	1990-94	2	D4387
XF				
	Hood	2009-15	2	D6782
	Trunk Lid	2009-15	2	E6783
XFR				
	Hood	2010-15	2	D6782
	Trunk Lid	2010-15	2	E6783
XFR-S				
	Hood	2013-15	2	D6782
	Trunk Lid	2013-15	2	E6783
XJ				
	Hood	2011-19	2	C7166
XJ12				
	Deck Lid	1995-96	2	E6922
	Hood	1995-96	2	D4385
	Hood	1994	2	D4387
	Hood	1988-92	2	D4387
XJ6				
	Deck Lid	1995-97	2	E6922
	Hood	1995-97	2	D4385
	Hood	1988-94	2	D4387
XJ8				
	Deck Lid	1998-03	2	E6922
	Hood	1998-03	2	D4385
XJR				
	Hood	2014-17	2	C7166
	Deck Lid	2000-03	2	E6922
	Hood	1995-03	2	D4385
XJS				
	Hood	1993-96	2	D6586
	Trunk Lid	1992-96	2	C6439
Base; To Chassis # 184671	Hood	1992	2	D4465
From Chassis # 184672	Hood	1992	1	D6586
	Hood	1976-91	2	D4465
XK				
	Hood	2007-15	2	C6585
Coupe; 2-Door	Trunk Lid	2007-15	2	D7046
XK8				
Convertible	Trunk Lid	2000-06	2	F6583
Coupe; 2-Door	Trunk Lid	2000-06	2	E6584
	Hood	1997-06	2	C6585

GAS CHARGED LIFT SUPPORTS ARE DESIGNED TO BE USED EXCLUSIVELY FOR THE PURPOSE SPECIFIED IN APPLICATION CHARTS. Tech Support 1-888-565-9632

MAKE & MODEL	LOCATION	YEAR	QTY	PART
Jaguar (cont.)				
XKR				
Coupe; 2-Door	Trunk Lid	2008-15	2	D7046
	Hood	2000-15	2	C6585
Convertible	Trunk Lid	2000-07	2	F6583
Coupe	Trunk Lid	2000-06	2	E6584
XKR-S				
	Hood	2012-15	2	C6585
X-Type				
	Hood	2002-08	2	E6302
Sedan; 4-Door; Base	Trunk Lid	2002-08	2	E6403
Sedan; 4-Door; Sport	Trunk Lid	2002-07	2	E6403
Sedan; 4-Door; VDP Edition	Trunk Lid	2006	2	E6403
Sedan; 4-Door; Premium	Trunk Lid	2005	2	E6403
Sedan; 4-Door; Vanden Plas	Trunk Lid	2005	2	E6403
Jeep				
Cherokee				
with Power Lift Gate	Liftgate, Gas Charged	2015-19	1	C7039
	Hood	2014-19	2	E6880
Except Power Lift Gate	Liftgate	2014-19	2	C6881
	Liftgate	1997-01	2	C4291
	Liftgate	1995-96	2	C4218
	Hatch	1984-94	2	C4782
Commander				
	Back Glass	2006-10	2	D6194
	Hood	2006-10	2	E6193
	Liftgate	2006-10	2	C6186
Compass				
Latitude; Except Articulating Liftgate Speakers	Liftgate	2011-17	2	C6187
Latitude; with Articulating Liftgate Speakers	Liftgate	2011-17	2	C6197
Sport; Except Articulating Liftgate Speakers	Liftgate	2007-17	2	C6187
Sport; with Articulating Liftgate Speakers	Liftgate	2007-17	2	C6197
Limited; Except Articulating Liftgate Speakers	Liftgate	2007-14	2	C6187
Limited; with Articulating Liftgate Speakers	Liftgate	2007-14	2	C6197
Base; Except Articulating Liftgate Speakers	Liftgate	2011	2	C6187
Base; with Articulating Liftgate Speakers	Liftgate	2011	2	C6197
Base; Except Articulating Liftgate Speakers	Liftgate	2007	2	C6187
Base; with Articulating Liftgate Speakers	Liftgate	2007	2	C6197
Grand Cherokee				
Limited	Hood	2022	2	C6485
	Hood	2011-21	2	C6485

MAKE & MODEL	LOCATION	YEAR	QTY	PART
Jeep (cont.)				
Grand Cherokee (cont.)				
Left; Except Power Liftgate	Liftgate	2014-20	1	B7181L
Right; Except Power Liftgate	Liftgate	2014-20	1	B7181R
with Power Lift Gate	Liftgate, Gas Charged	2014-16	1	B6775
	Back Glass	2011-13	2	E6487
with Power Lift Gate	Liftgate, Gas Charged	2011-13	1	B6486
without Power Lift Gate	Liftgate	2011-13	2	B6664
	Hatch	2008-10	2	D6379
	Back Glass	2005-10	2	E6601
	Hood	2005-10	2	E6304
	Hatch	2005-07	2	D6104
	Back Glass	1999-04	2	E4528
	Hood	1999-04	2	E4048
	Liftgate	1999-04	2	D4699
	Back Glass	1994-98	2	D4678
Left; To 01/03/1995	Hatch	1993-98	1	D4857
Right	Hatch	1993-98	1	D4856
Grand Wagoneer				
	Hatch	1993	2	C4782
Liberty				
From 09/29/2008	Back Glass	2009-13	2	D6382
From 09/29/2008	Hatch	2009-13	2	C6381
To 09/29/2008	Hatch	2008-09	2	C6380
	Back Glass	2002-07	2	D4365
	Hood	2002-07	2	D4366
Patriot				
Latitude; Except Articulating Liftgate Speakers	Liftgate	2017	2	C6187
Latitude; with Articulating Liftgate Speakers	Liftgate	2017	2	C6197
Sport; Except Articulating Liftgate Speakers	Liftgate	2017	2	C6187
Sport; with Articulating Liftgate Speakers	Liftgate	2017	2	C6197
Except Articulating Speakers	Hatch	2007-16	2	D6138
with Articulating Liftgate Speakers	Hatch	2007-16	2	D6831
TJ				
	Back Glass	1997-06	2	C4249
Wagoneer				
	Hatch	1984-90	2	C4782
Wrangler				
	Back Glass	2011-17	2	D6678
	Back Glass	2007-10	2	C6602
	Back Glass	1997-06	2	C4249
	Back Glass	1987-95	2	C4761
Wrangler JK				
	Back Glass	2018	2	D6678

GAS CHARGED LIFT SUPPORTS ARE DESIGNED TO BE USED EXCLUSIVELY FOR THE PURPOSE SPECIFIED IN APPLICATION CHARTS.

Tech Support 1-888-565-9632

APPLICATION GUIDE / GUÍA DE APLICACIONES / GUIDE D'APPLICATIONS

MAKE & MODEL	LOCATION	YEAR	QTY	PART
Kia				
Amanti				
	Hood	2007-09	2	D6488
	Hood	2004-06	2	C6311
	Trunk Lid	2004-06	2	E6407
Borrego				
HM Body	Hatch	2009-11	2	D6476
HM Body	Hood	2009-11	2	D6475
Cadenza				
	Hood	2014-16	2	E7067
Forte				
	Hatch	2011-13	2	D7145
Optima				
EX	Hood	2020	1	D7005
EX Premium	Hood	2020	1	D7005
LX	Hood	2020	1	D7005
S	Hood	2020	1	D7005
Special Edition	Hood	2020	1	D7005
SX	Hood	2020	1	D7005
	Hood	2016-19	2	D7005
USA Built	Hood	2011-15	1	C6765
SX	Hood	2009-10	1	C6195
EX; 2nd Design	Hood	2006-10	1	C6195
LX; 2nd Design	Hood	2006-10	1	C6195
Old Design	Trunk Lid	2006	2	E4063
EX	Hood	2004-05	2	D6329
LX	Hood	2003-05	2	D6329
	Trunk Lid	2001-05	2	E4063
SE	Hood	2003	2	D6329
Rio				
Wagon	Tailgate	2002-05	2	C6202
Rondo				
	Hatch	2007-10	2	C6134
Sedona				
with Power Lift Gate	Liftgate, Gas Charged	2014	2	C7013
	Hood	2006-12	2	E6326
with Power Lift Gate	Liftgate, Gas Charged	2006-12	2	C7013
without Power Lift Gate	Liftgate	2006-12	2	C6118
	Hood	2003-05	2	E6314
	Liftgate	2002-05	2	B4588
Sorento				
Except Power Lift Gate	Hood	2016-20	2	E7011
	Liftgate	2016-20	2	D7012
	Liftgate	2014-15	2	D6876
	Hood	2011-15	1	D6267
	Liftgate	2011-13	2	D6261
	Back Glass	2003-09	2	E6603
	Hood	2003-09	2	C6305
	Liftgate	2003-09	2	C6105

MAKE & MODEL	LOCATION	YEAR	QTY	PART
Kia (cont.)				
Soul				
	Hood	2014-19	2	B7154
	Liftgate	2014-19	2	C7174
	Liftgate	2010-13	2	D6652
Soul EV				
	Liftgate	2015-19	2	C7174
Spectra				
Left; without Rear Wiper	Hatch	2000-04	1	A6517L
Right; without Rear Wiper	Hatch	2000-04	1	A6517R
Sportage				
	Liftgate	2011-16	2	D6708
	Back Glass	2005-10	2	D7072
	Liftgate	2005-10	2	C7047
Left	Liftgate	1995-02	1	D4594L
Right; with Rear Wiper	Liftgate	1995-02	1	D4594R
Right; without Rear Wiper	Liftgate	1995-99	1	D6715
Land Rover				
Discovery Sport				
	Hood	2016-21	2	E7118
Freelander				
Rear	Door	2002-06	1	C6234
LR3				
	Back Glass	2005-09	2	D6614
	Hood	2005-09	2	C6358
LR4				
	Back Glass	2010-16	2	D6614
	Hood	2010-16	2	C6358
Range Rover				
	Hatch	2003-12	2	D6619
	Hood	2003-12	2	E7028
	Hatch	1999-02	2	E7035
without Pad	Hood	1996-02	2	C6691
	Tailgate	1990-95	2	D4647
Range Rover Evoque				
	Hood	2012-19	2	E7185
; with Power Lift Gate	Power Liftgate	2012-17	2	PG5013
Range Rover Sport				
; with Power Lift Gate	Power Liftgate	2014-20	2	PG5020
	Hood	2006-16	2	C6358
	Back Glass	2008-13	2	C7160
; with Power Lift Gate	Power Liftgate	2012-13	2	PG5019
	Liftgate	2006-11	2	C7057
Lexus				
CT200h				
without Rear Wiper	Hatch	2011-12	2	D6658
ES300				
	Hood	2002-03	1	B4172
	Hood	1997-01	2	D4547
Left	Hood	1992-96	1	D4217L

GAS CHARGED LIFT SUPPORTS ARE DESIGNED TO BE USED EXCLUSIVELY FOR THE PURPOSE SPECIFIED IN APPLICATION CHARTS. Tech Support 1-888-565-9632

MAKE & MODEL	LOCATION	YEAR	QTY	PART
Lexus (cont.)				
ES300 (cont.)				
Right	Hood	1992-96	1	D4217R
ES300h				
	Hood	2013-18	2	C7156
ES330				
	Hood	2004-06	1	B4172
ES350				
	Hood	2013-18	2	C7156
	Hood	2007-12	2	B6477
GS300				
From 01/2005	Hood	2005-06	2	D6653
To 01/2005	Hood	2005	2	D4536
	Hood	1998-04	2	D4536
	Hood	1993-97	2	D4381
Left	Trunk Lid	1993-97	1	D4382L
Right	Trunk Lid	1993-97	1	D4382R
GS350				
	Hood	2007-11	2	D6653
	Trunk Lid	2007-11	2	E6654
GS400				
	Hood	1998-00	2	D4536
GS430				
From 01/2005	Hood	2005-07	2	D6653
	Hood	2001-04	2	D4536
GS450h				
	Hood	2007-11	2	D6653
	Trunk Lid	2007-11	2	E6654
GS460				
	Hood	2008-11	2	D6653
	Trunk Lid	2008-11	2	E6654
GX470				
	Hood	2003-09	2	D6228
IS F				
	Trunk Lid	2010-14	2	E6798
IS250				
	Trunk Lid	2010-15	2	E6798
	Hood	2006-15	2	D6797
IS300				
Wagon; 4-Door	Hatch	2002-04	2	C6237
IS350				
	Trunk Lid	2010-15	2	E6798
	Hood	2006-15	2	D6797
LS400				
	Hood	1998-00	2	D6301
	Hood	1995-97	2	D4566
	Hood	1990-94	2	C4572
LS430				
	Hood	2001-06	2	D6236
	Trunk Lid	2001-06	2	E6415

MAKE & MODEL	LOCATION	YEAR	QTY	PART
Lexus (cont.)				
LS460				
	Hood	2007-12	2	C6779
LS600h				
	Hood	2008-12	2	C6779
LX450				
Left	Hood	1996-97	1	D4551L
Right	Hood	1996-97	1	D4551R
	Tailgate	1996-97	2	D4526
LX470				
Left	Hatch	1998-07	1	D4362L
Right	Hatch	1998-07	1	D4362R
	Hood	1998-07	2	D4361
LX570				
Left	Hatch	2008-09	1	D4362L
RX300				
	Hood	1999-03	2	D4183
	Liftgate	1999-03	2	C6102
RX330				
	Hood	2004-06	1	C4179
	Liftgate	2004-06	2	D6127
RX350				
Except Japan Built	Hood	2010-15	2	D6755
with Power Lift Gate	Tailgate	2010-15	2	C6756
Japan Built	Liftgate	2010-12	2	C6754
	Hatch	2007-09	2	D6135
Except Japan Built	Hood	2007-09	1	C4179
Japan Built	Hood	2007-09	1	C6361
RX400h				
	Hood	2008	1	C6361
	Hatch	2006-08	2	D6135
	Hood	2006-07	1	C4179
RX450h				
Except Japan Built	Hood	2010-15	2	D6755
with Power Lift Gate	Tailgate	2010-15	2	C6756
Except Premium Package	Liftgate	2010-12	2	C6754
SC300				
	Hood	1992-00	2	C6308
with Spoiler	Trunk Lid	1992-00	2	E4508
without Spoiler	Trunk Lid	1992-00	2	E4500
SC400				
	Hood	1992-00	2	C6308
with Spoiler	Trunk Lid	1992-00	2	E4508
without Spoiler	Trunk Lid	1992-00	2	E4500
SC430				
Convertible; 2-Door	Hood	2002-10	2	E6232
with Spoiler	Trunk Lid	2002-10	2	E6423
without Spoiler	Trunk Lid	2002-10	2	E7089

GAS CHARGED LIFT SUPPORTS ARE DESIGNED TO BE USED EXCLUSIVELY FOR THE PURPOSE SPECIFIED IN APPLICATION CHARTS. Tech Support 1-888-565-9632

APPLICATION GUIDE / GUÍA DE APLICACIONES / GUIDE D'APPLICATIONS



MAKE & MODEL	LOCATION	YEAR	QTY	PART
Lincoln				
Aviator				
	Back Glass	2003-05	2	D6605
	Hood	2003-05	2	D6318
	Liftgate	2003-05	2	C4584
Blackwood				
	Hood	2002-03	2	D4341
Continental				
	Hood	1998-02	2	D4354
	Hood	1995-97	2	D4340
	Hood	1988-94	2	D4615
with Steel Hood	Hood	1982-86	2	F4104
From 02/1982	Trunk Lid	1982-83	2	F4105
From 03/1981; To 02/1982; with Ball Type End Fittings	Trunk Lid	1982	2	F4607
with Steel Hood	Hood	1980	2	F4104
To 03/1981	Trunk Lid	1980	2	F4875
LS				
	Hood	2000-06	2	D4169
Mark LT				
	Hood	2008	2	D4153
Crew Cab Pickup; 4-Door	Hood	2006-07	2	D4169
Mark VI				
From 02/1982; with Blade Type End Fittings	Trunk Lid	1982-83	2	E4616
From 03/1981; To 02/1982; with Ball Type End Fittings	Trunk Lid	1981-83	2	E4882
with Steel Hood	Hood	1980-83	2	F4104
To 03/1981	Trunk Lid	1980-81	2	F4874
Mark VIII				
	Hood	1997-98	2	D4323
	Hood	1993-96	2	D4881
MKS				
	Trunk Lid	2013-16	2	E6760
	Hood	2009-12	2	C6562
	Trunk Lid	2009-12	2	E6563
MKT				
	Hood	2010-19	2	C6776
	Tailgate	2010-19	2	C6777
MKX				
with Power Lift Gate	Liftgate, Gas Charged	2011-15	2	C6882
with Power Lift Gate	Hatch	2007-10	2	C6684
MKZ				
	Hood	2013-16	2	C6027
with Spoiler	Trunk Lid	2010-12	2	E6675
From 08/30/2006; To 01/19/2007	Trunk Lid	2007	2	E6393
Navigator				
	Back Glass	2007-17	2	D6253
	Hood	2007-17	2	E4525

MAKE & MODEL	LOCATION	YEAR	QTY	PART
Lincoln (cont.)				
Navigator (cont.)				
	Liftgate	2003-17	2	C6106
	Back Glass	2003-06	2	D4191
	Hood	2003-06	2	D6306
	Back Glass	1998-02	2	D4676
	Hood	1998-02	2	D4341
	Liftgate	1998-02	2	C4964
Town Car				
	Hood	2003-05	2	E4155
	Hood	1998-02	2	E4467
	Hood	1990-97	2	E4466
with Aluminum Hood	Hood	1986-89	2	F4106
	Trunk Lid	1984-89	2	F4105
with Steel Hood	Hood	1981-86	2	F4104
From 02/1982	Trunk Lid	1982-83	2	E4479
From 03/1981; To 02/1982	Trunk Lid	1981-82	2	E4453
Versailles				
To 03/1981	Trunk Lid	1980	2	F4875
Maserati				
Quattroporte				
	Hood	1979-86	2	C6370
Mazda				
2				
	Hatch	2011-14	2	D6701
3				
Mexico Built	Hatch	2014-18	2	C7004
	Trunk Lid	2010-13	2	F6786
Mazdaspeed; with Spoiler; with Wiper	Hatch	2007-09	2	D6800
i	Hatch	2004-09	2	C6371
S	Hatch	2004-09	2	C6371
Sedan; 4-Door; without Spoiler	Trunk Lid	2004-09	2	F6410
SP23	Hatch	2005	2	C6371
323				
Left	Hatch	1990-95	1	C4912
Right	Hatch	1990-95	2	C4911
Wagon; 4-Door	Tailgate	1987-88	2	B4980
Left; without Wiper	Hatch	1986-88	1	C4910
Right; without Wiper	Hatch	1986-88	1	C4907
5				
	Hatch	2012-15	2	D6685
6				
Sedan	Trunk Lid	2006-13	2	F7138
Hatchback	Hatch	2004-08	2	C6519
Wagon; S	Tailgate	2004-07	2	D4358
Sedan	Trunk Lid	2003-05	2	E4048
626				
Left	Hatch	1983-85	1	B4735

GAS CHARGED LIFT SUPPORTS ARE DESIGNED TO BE USED EXCLUSIVELY FOR THE PURPOSE SPECIFIED IN APPLICATION CHARTS. Tech Support 1-888-565-9632

MAKE & MODEL	LOCATION	YEAR	QTY	PART
Mazda (cont.)				
626 (cont.)				
Right	Hatch	1983-85	1	B4741
929				
	Hood	1992-95	2	C4282
Left	Trunk Lid	1992-95	1	B4998L
Right	Trunk Lid	1992-95	1	B4998R
	Hood	1988-91	2	D4213
CX-9				
without Power Lift Gate	Hatch	2007-15	2	D6661
GLC				
	Tailgate	1985	2	C4215
	Hatch	1981-85	2	B4711
Hatchback	Hatch	1977-80	2	B4778
MPV				
Left	Liftgate	2000-06	1	C6113L
Right	Liftgate	2000-06	1	C6113R
with Wiper	Liftgate	1989-98	2	C4212
MX-3				
with Rear Wiper	Hatch	1992-96	2	B4984
MX-5 Miata				
Except Power Retractable Hardtop	Deck Lid	2016-21	2	F7021
Except Power Retractable Hardtop	Deck Lid	2006-15	2	F6735
MX-6				
with Spoiler	Hatch	1993-97	2	D4639
without Spoiler	Hatch	1993-97	2	D4638
Navajo				
	Back Glass	1991-94	2	D4608
	Hatch	1991-94	2	C4754
Protege5				
Left	Hatch	2002-03	1	C6203L
Right	Hatch	2002-03	1	C6203R
RX-7				
	Hatch	1993-95	2	C4309
with Wiper	Hatch	1986-91	2	A6229
with Rear Defroster; with Wiper	Hatch	1979-85	2	C4709
RX-8				
	Trunk Lid	2004-11	2	F6427
Tribute				
	Back Glass	2008-11	2	D6260
	Hatch	2008-11	2	C4370
	Back Glass	2001-06	2	D4187
	Hatch	2001-06	2	C4596
Mercedes-Benz				
190D				
	Hood	1984-89	1	B4809
190E				
	Hood	1985-93	2	B4809

MAKE & MODEL	LOCATION	YEAR	QTY	PART
Mercedes-Benz (cont.)				
300CE				
	Trunk Lid	1993	2	E4050
300SL				
Convertible; 2-Door	Deck Lid	1990-93	2	E4049
500SL				
Convertible; 2-Door	Deck Lid	1990-93	2	E4049
600SL				
Convertible; 2-Door	Deck Lid	1993	2	E4049
AMG GT				
	Hood	2017-21	2	E7033
AMG GT C				
	Hood	2018-21	2	E7033
AMG GT R				
	Hood	2018-20	2	E7033
AMG GT R Pro				
	Hood	2020	2	E7033
AMG GT S				
	Hood	2016-19	2	E7033
C180				
	Hood	2012-15	2	C7020
C200				
	Hood	2013	2	C7020
C220				
	Hood	1994-97	2	F4114
C230				
	Hood	2002-09	1	C6360
	Hatch	2002-05	2	C6525
	Trunk Lid	2002-05	2	C6588
	Hood	1997-00	2	F4114
C240				
	Hatch	2001-05	2	D6589
	Hood	2001-05	1	C6360
C250				
Luxury	Hood	2012-14	2	C7020
Sport	Hood	2012-14	2	C7020
C280				
	Hood	2006-09	1	C6360
	Hood	1994-00	2	F4114
C300				
	Hood	2008-12	2	C6190
C32 AMG				
	Hood	2002-04	1	C6360
C320				
	Hatch	2004-05	2	C6525
	Trunk Lid	2004-05	2	C6588
	Hood	2001-05	1	C6360
C350				
	Hood	2012-15	2	C7020
	Hood	2008-11	2	C6190
	Hood	2006-07	1	C6360

GAS CHARGED LIFT SUPPORTS ARE DESIGNED TO BE USED EXCLUSIVELY FOR THE PURPOSE SPECIFIED IN APPLICATION CHARTS. Tech Support 1-888-565-9632

APPLICATION GUIDE / GUÍA DE APLICACIONES / GUIDE D'APPLICATIONS



MAKE & MODEL	LOCATION	YEAR	QTY	PART
Mercedes-Benz (cont.)				
C36 AMG				
	Hood	1995-97	2	F4114
C43 AMG				
	Hood	1998-00	2	F4114
C55 AMG				
	Hood	2005-07	1	C6360
C63 AMG				
	Hood	2012-15	2	C7020
	Hood	2008-11	2	C6190
CL500				
	Hood	2000-07	2	B6270
CL55 AMG				
	Hood	2005-06	1	C6360
	Hood	2001-04	2	B6270
CL600				
	Hood	2001-07	2	B6270
CL65 AMG				
	Hood	2005-06	2	B6270
CLK320				
Convertible; 2-Door	Trunk Lid	2004-05	2	F6590
Coupe; 2-Door	Trunk Lid	2004-05	2	F6591
	Trunk Lid	1999-03	2	F6442
	Hood	1998-03	2	D6276
CLK430				
	Hood	1999-03	2	D6276
	Trunk Lid	1999-03	2	F6442
CLK55 AMG				
	Trunk Lid	2004-06	2	F6592
	Hood	2001-02	2	D6276
	Trunk Lid	2001-02	2	F6442
CLK550				
	Trunk Lid	2007-09	2	F6592
CLK63 AMG				
	Trunk Lid	2007-09	2	F6592
CLS400				
	Hood	2015-16	2	C6323
CLS500				
	Hood	2006	2	C6323
CLS55 AMG				
	Hood	2006	2	C6323
CLS550				
	Hood	2007-16	2	C6323
CLS63 AMG				
	Hood	2007-11	2	C6323
E200				
	Hood	2012-16	2	C7020
E250				
	Hood	2011-16	2	C7020
E300				
Sedan; 4-Door	Hood	2010-16	2	C7020

MAKE & MODEL	LOCATION	YEAR	QTY	PART
Mercedes-Benz (cont.)				
E300 (cont.)				
Coupe; 2-Door	Hood	2010	2	C7020
	Hood	1995-99	2	D4537
E320				
	Hood	2004-09	2	C6323
	Hatch	2004-05	2	E6594
Wagon; 4-Door	Hatch	1998-03	2	E6293
	Hood	1995-03	2	D4537
	Trunk Lid	1994-95	2	E4050
E350				
Wagon; 4-Door	Hood	2011-16	2	C7020
Sedan; 4-Door	Hood	2010-16	2	C7020
Convertible; 2-Door	Hood	2011-14	2	C7020
Coupe; 2-Door	Hood	2010-14	2	C7020
	Hood	2006-09	2	C6323
E400				
Convertible; 2-Door	Hood	2014-17	2	C7020
Coupe; 2-Door	Hood	2014-17	2	C7020
Sedan; 4-Door	Hood	2013-16	2	C7020
Wagon; 4-Door	Hood	2015	2	C7020
E420				
	Hood	1997-99	2	D4537
	Hood	1994-95	2	D4537
E430				
	Hood	1998-02	2	D4537
E500				
Convertible; 2-Door	Hood	2011-17	2	C7020
Coupe; 2-Door	Hood	2010-17	2	C7020
Sedan; 4-Door	Hood	2013-16	2	C7020
with Power Lift Gate	Hatch	2006	2	E6594
	Hood	2003-06	2	C6323
E55 AMG				
with Power Lift Gate	Hatch	2006	2	E6594
	Hood	2004-06	2	C6323
	Hood	1998-03	2	D4537
E550				
4Matic	Hood	2012-14	2	C7020
	Hood	2010-11	2	C7020
	Hood	2007-09	2	C6323
E63 AMG				
Sedan; 4-Door	Hood	2010-16	2	C7020
Wagon; 4-Door	Hood	2012-14	2	C7020
	Hood	2007-09	2	C6323
with Power Lift Gate	Hatch	2007	2	E6594
E63 AMG S				
	Hood	2014-16	2	C7020
G500				
	Hood	2002-11	1	A6689

GAS CHARGED LIFT SUPPORTS ARE DESIGNED TO BE USED EXCLUSIVELY FOR THE PURPOSE SPECIFIED IN APPLICATION CHARTS. Tech Support 1-888-565-9632

MAKE & MODEL	LOCATION	YEAR	QTY	PART
Mercedes-Benz (cont.)				
G55 AMG				
	Hood	2003-11	1	A6689
G550				
	Hood	2009-17	1	A6689
G63 AMG				
	Hood	2013-17	1	A6689
G65 AMG				
	Hood	2016-18	1	A6689
GL320				
Left	Hood	2007-09	1	C6006L
Right	Hood	2007-09	1	C6006R
GL350				
Left	Hood	2010-12	1	C6006L
Right	Hood	2010-12	1	C6006R
GL450				
Left	Hood	2008-12	1	C6006L
Right	Hood	2008-12	1	C6006R
	Hood	2007	2	F6319
GL550				
Left	Hood	2008-12	1	C6006L
Right	Hood	2008-12	1	C6006R
GLK250				
Except Power Liftgate	Hatch	2013-15	2	D7052
Left	Hood	2013-15	1	C7175L
Right	Hood	2013-15	1	C7175R
GLK280				
Left	Hood	2009	1	C7175L
Right	Hood	2009	1	C7175R
GLK300				
Left	Hood	2010-15	1	C7175L
Right	Hood	2010-15	1	C7175R
GLK350				
Except Power Liftgate	Hatch	2010-15	2	D7052
Left	Hood	2010-15	1	C7175L
Right	Hood	2010-15	1	C7175R
ML320				
without Power Lift Gate	Hatch	2007-09	2	C6693
Left	Hood	2007-09	1	C7164L
Right	Hood	2007-09	1	C7164R
	Hatch	1998-03	2	C6114
	Hood	1998-03	2	F6319
ML350				
without Power Lift Gate	Hatch	2006-11	2	C6693
Left	Hood	2006-11	1	C7164L
Right	Hood	2006-11	1	C7164R
	Hatch	2003-05	2	C6114
	Hood	2003-05	2	F6319
ML430				
	Hatch	1999-01	2	C6114

MAKE & MODEL	LOCATION	YEAR	QTY	PART
Mercedes-Benz (cont.)				
ML430 (cont.)				
	Hood	1999-01	2	F6319
ML450				
without Power Lift Gate	Hatch	2010-11	2	C6693
Left	Hood	2010-11	1	C7164L
Right	Hood	2010-11	1	C7164R
ML500				
	Hatch	2002-07	2	C6114
	Hood	2002-07	2	F6319
ML55 AMG				
	Hatch	2000-03	2	C6114
	Hood	2000-03	2	F6319
ML550				
without Power Lift Gate	Hatch	2008-11	2	C6693
Left	Hood	2008-11	1	C7164L
Right	Hood	2008-11	1	C7164R
ML63 AMG				
without Power Lift Gate	Hatch	2007-11	2	C6693
Left	Hood	2007-11	1	C7164L
Right	Hood	2007-11	1	C7164R
R320				
Left	Hood	2007-09	1	E6852
Right	Hood	2007-09	1	D6853
R350				
Left	Hood	2011-12	1	E7165L
Right	Hood	2011-12	1	E7165R
Left	Hood	2006-10	1	E6852
Right	Hood	2006-10	1	D6853
R500				
Left	Hood	2006-08	1	E6852
Right	Hood	2006-08	1	D6853
R63 AMG				
Left	Hood	2007	1	E6852
Right	Hood	2007	1	D6853
S350				
	Hood	2006	2	C6323
S430				
	Hood	2000-06	2	B6362
S500				
	Hood	2007-10	2	C6323
	Hood	2000-06	2	B6362
S55 AMG				
	Hood	2001-06	2	B6362
S600				
	Hood	2007-10	2	C6323
	Hood	2001-06	2	B6362
S63 AMG				
	Hood	2008-13	2	C6323

GAS CHARGED LIFT SUPPORTS ARE DESIGNED TO BE USED EXCLUSIVELY FOR THE PURPOSE SPECIFIED IN APPLICATION CHARTS.

Tech Support 1-888-565-9632

APPLICATION GUIDE / GUÍA DE APLICACIONES / GUIDE D'APPLICATIONS

MAKE & MODEL	LOCATION	YEAR	QTY	PART
Mercedes-Benz (cont.)				
S65 AMG				
	Hood	2006-10	2	C6323
SL320				
Convertible; 2-Door	Deck Lid	1994-97	2	E4049
SL500				
Convertible; MEX	Deck Lid	2012-14	2	E6023
Convertible; 2-Door; To Chassis # 113587	Deck Lid	2003-07	2	E6634
	Hood	2003-06	2	E6699
Convertible; 2-Door	Deck Lid	2002	2	F6698
Convertible; 2-Door	Deck Lid	1994-01	2	E4049
SL55 AMG				
Convertible; 2-Door	Deck Lid	2003-08	2	E6634
	Hood	2003-08	2	E6699
SL550				
	Hood	2010-12	2	C6323
	Hood	2007-08	2	E6699
SL600				
	Hood	2004-08	2	E6699
Front	Deck Lid	2004-06	2	E6634
	Deck Lid	1994-02	2	F6698
SL65 AMG				
	Hood	2005-08	2	E6699
Convertible; 2-Door	Deck Lid	2005-07	2	E6634
SLK230				
	Hood	1998-04	2	A6343
SLK280				
Convertible	Deck Lid	2006-08	2	F6026
	Hood	2006-08	2	C6690
SLK300				
Convertible	Deck Lid	2009-11	2	F6026
	Hood	2009-11	2	C6690
SLK32 AMG				
	Hood	2002-04	2	A6343
SLK320				
	Hood	2001-04	2	A6343
SLK350				
Convertible	Deck Lid	2005-11	2	F6026
	Hood	2005-11	2	C6690
SLK55 AMG				
Convertible	Deck Lid	2005-11	2	F6026
	Hood	2005-10	2	C6690
SLR McLaren				
	Trunk Lid	2005-06	2	F6700
SLS AMG				
	Hood	2011-15	2	E7033
Mercury				
Bobcat				
	Back Glass	1975-80	2	D4405

MAKE & MODEL	LOCATION	YEAR	QTY	PART
Mercury (cont.)				
Capri				
Convertible; 2-Door; with Spoiler	Deck Lid	1991-94	2	E4626
Convertible; 2-Door; without Spoiler	Deck Lid	1991-94	2	E4625
with Spoiler	Hatch	1979-86	2	D4686
without Spoiler	Hatch	1979-86	2	D4408
Cougar				
Coupe; 2-Door	Hatch	1999-02	2	D4331
	Hood	1989-97	2	D4462
Wagon; 4-Door	Back Glass	1982	2	C4720
Wagon; 4-Door	Tailgate	1982	2	D4408
Grand Marquis				
Early Design	Hood	1998-11	2	E4550
	Hood	1992-97	2	E4467
	Back Glass	1984-86	2	D4689
	Hatch	1983-86	2	D4686
LN7				
	Hatch	1982-83	2	D4415
Lynx				
with Rear Defroster	Hatch	1981-87	2	C4722
without Rear Defroster	Hatch	1981-87	2	C4732
Marauder				
	Hood	2003-04	2	E4550
Mariner				
	Back Glass	2008-11	2	D6260
	Hatch	2005-11	2	C4370
	Back Glass	2005-07	2	C4369
Marquis				
Wagon; 4-Door	Back Glass	1983-86	2	C4720
Wagon; 4-Door	Tailgate	1983-86	2	D4408
	Back Glass	1982	2	D4405
Milan				
with Spoiler	Trunk Lid	2010-11	2	E6675
From 12/01/2006	Trunk Lid	2007-09	2	E6393
To 12/04/2006	Trunk Lid	2006-07	2	E4075
Montego				
	Trunk Lid	2005-07	2	E4074
Monterey				
with Power Lift Gate	Liftgate, Gas Charged	2004-07	2	C6447
without Power Lift Gate	Liftgate	2004-07	2	C4593
Mountaineer				
	Back Glass	2008-10	2	D6615
	Hood	2002-10	2	E4143
	Liftgate	2002-10	2	C4584
	Back Glass	2005-07	2	D6624
From 07/2002	Back Glass	2004	2	D6609
From 03/04/2002; To 05/05/2003	Back Glass	2002-03	2	D4372

GAS CHARGED LIFT SUPPORTS ARE DESIGNED TO BE USED EXCLUSIVELY FOR THE PURPOSE SPECIFIED IN APPLICATION CHARTS. Tech Support 1-888-565-9632

MAKE & MODEL	LOCATION	YEAR	QTY	PART
Mercury (cont.)				
Mountaineer (cont.)				
	Back Glass	1997-01	2	D4608
	Hatch	1997-01	2	C4754
	Hood	1997-01	2	F4026
Mystique				
with Spoiler	Trunk Lid	1995-00	2	E4475
without Spoiler	Trunk Lid	1995-00	2	E4506
Sable				
	Trunk Lid	2008-09	2	E4074
	Hood	2000-05	2	C4368
Wagon; 4-Door	Back Glass	1996-05	2	D4646
Wagon; 4-Door	Tailgate	1996-05	2	C4205
	Hood	1996-99	2	C4204
Wagon; 4-Door	Back Glass	1986-95	2	D4440
without Hood Light	Hood	1986-95	2	D4439
Wagon; 4-Door	Tailgate	1986-95	2	D4601
with Hood Light	Hood	1986-91	2	D4214
Tracer				
Wagon; 4-Door	Tailgate	1998-99	2	D4538
Left; without Spoiler	Hatch	1991-99	1	B4840
Right; without Spoiler	Hatch	1991-99	1	B4839
without Rear Wiper	Hatch	1991-99	2	B4896
Wagon; 4-Door; without Rear Wiper	Tailgate	1993-96	2	D4649
Wagon; 4-Door	Tailgate	1991-92	2	D4681
	Hatch	1988-89	2	C4721
Left; Wagon; 4-Door	Tailgate	1988-89	1	C4939
Right; Wagon; 4-Door	Tailgate	1988-89	1	C4938
Villager				
	Back Glass	1999-02	2	D4356
with Flip Window	Liftgate	1999-02	2	C4555
without Flip Window	Liftgate	1999-02	2	C4556
	Back Glass	1993-98	2	D4645
GS; To 12/14/1995; with Wiper	Liftgate	1993-96	2	C4202
Zephyr				
	Back Glass	1978-83	2	D4405
Wagon; 4-Door	Tailgate	1978-81	2	D4408
Merkur				
Scorpio				
	Hatch	1988-89	2	D4499
XR4Ti				
	Hatch	1985-89	2	D4443
Mini				
Cooper				
	Hood	2016	2	C6553
L4 1.6L 1597cc 98cid	Hood	2015	2	F6030
L4 1.6L 1598cc	Hood	2015	2	F6030
Clubman	Hatch	2014	1	E7055

MAKE & MODEL	LOCATION	YEAR	QTY	PART
Mini (cont.)				
Cooper (cont.)				
John Cooper Works Clubman	Hatch	2014	1	E7055
S Clubman	Hatch	2014	1	E7055
	Hood	2007-14	2	F6030
Base	Hatch	2013	1	D7069
Clubman	Hatch	2013	1	D7069
John Cooper Works	Hatch	2013	1	D7069
John Cooper Works Clubman	Hatch	2013	1	D7069
John Cooper Works GP	Hatch	2013	1	D7069
S	Hatch	2013	1	D7069
S Clubman	Hatch	2013	1	D7069
Base	Hatch	2009-12	2	D7069
Clubman	Hatch	2009-12	1	E7055
John Cooper Works	Hatch	2009-12	2	D7069
John Cooper Works Clubman	Hatch	2009-12	1	E7055
S	Hatch	2009-12	2	D7069
S Clubman	Hatch	2009-12	1	E7055
Clubman	Hatch	2008	2	E7055
N12B16A; Base	Hatch	2008	1	D7069
N14B16A; S	Hatch	2008	1	D7069
S Clubman	Hatch	2008	2	E7055
W10B16A; Base	Hatch	2007-08	1	D4360
W11B16A; S	Hatch	2007-08	1	D4360
N12B16A	Hatch	2007	1	D7069
N14B16A	Hatch	2007	1	D7069
	Hatch	2002-06	2	D4360
	Hood	2002-06	2	C6309
Cooper Countryman				
	Hatch	2011-16	2	D7049
	Hood	2011-16	2	E7140
Cooper Paceman				
	Hood	2013-16	2	E7140
Mitsubishi				
3000GT				
Coupe; 2-Door; without Rear Wiper	Hatch	1991-99	2	A4982
Left	Hood	1991-99	1	D4523L
Right	Hood	1991-99	1	D4523R
Diamante				
Left	Hood	2002-04	1	C4163L
Right	Hood	2002-04	1	C4163R
Left	Hood	1997-01	1	D4548L
Right	Hood	1997-01	1	D4548R
Left	Hood	1992-96	1	D4569L
Right	Hood	1992-96	1	D4569R
Wagon; 4-Door; ES	Hatch	1993-95	2	C4367

GAS CHARGED LIFT SUPPORTS ARE DESIGNED TO BE USED EXCLUSIVELY FOR THE PURPOSE SPECIFIED IN APPLICATION CHARTS.

Tech Support 1-888-565-9632

APPLICATION GUIDE / GUÍA DE APLICACIONES / GUIDE D'APPLICATIONS



MAKE & MODEL	LOCATION	YEAR	QTY	PART
Mitsubishi (cont.)				
Eclipse				
	Hatch	2006-12	2	D6172
	Trunk Lid	2007-11	2	F6231
without Rear Spoiler	Trunk Lid	2001-05	2	E4133
with Spoiler	Trunk Lid	2001-04	2	E4137
with Spoiler; with Wiper	Hatch	2000-04	2	E4135
without Spoiler; without Wiper	Hatch	2000-04	2	E4132
Convertible; 2-Door	Deck Lid	1997-99	2	D4667
Left	Hatch	1995-99	1	A4952L
Right	Hatch	1995-99	1	A4952R
	Hatch	1990-94	2	C4731
Endeavor				
	Liftgate	2010-11	2	D6832
	Back Glass	2004-08	2	D4193
	Liftgate	2004-08	2	D4592
Galant				
From 12/2007	Trunk Lid	2008-12	2	E6180
To 12/2007	Trunk Lid	2004-08	2	E4095
Lancer				
with Spoiler	Trunk Lid	2008-16	2	E7079
without Spoiler	Trunk Lid	2008-16	2	E7006
Mirage				
Left	Hatch	1989-93	1	C4961L
Right	Hatch	1989-93	1	C4961R
Montero				
	Hatch	1997-04	2	D4554
Montero Sport				
	Hatch	1997-04	2	D4554
Outlander				
without Power Lift Gate	Liftgate	2007-13	2	D7026
	Liftgate	2003-06	2	D6115
Outlander Sport				
without Power Lift Gate	Liftgate	2012-15	2	D7027
Precis				
Right; Base	Hatch	1993-94	1	B4303R
Left; Base	Hatch	1990-94	1	B4303L
	Hatch	1987-89	2	C4725
Raider				
	Hood	2006-09	2	D6312
Nissan				
200SX				
	Hatch	1984-88	2	B4806
	Hatch	1980-83	2	C4703
210				
	Hatch	1979-82	2	D4429
Wagon; 4-Door	Tailgate	1979-82	2	C4853
240SX				
without Spoiler	Hatch	1990-93	2	C4285
From 07/1988	Hatch	1989-90	2	C4756

MAKE & MODEL	LOCATION	YEAR	QTY	PART
Nissan (cont.)				
240Z				
	Hatch	1970-73	2	C4313
260Z				
	Hatch	1974-75	2	C4777
280Z				
	Hatch	1975-78	2	C4777
280ZX				
2 Seat(s)	Hatch	1979-83	1	B4800
4 Seats	Hatch	1979-83	1	B4807
300ZX				
From 02/1989; without Spoiler; 2 Passenger	Hatch	1989-96	2	B4814
From 02/1989; 4 Passenger	Hatch	1989-94	2	B4829
From 02/1989; with Spoiler; 2 Passenger	Hatch	1989-93	2	B4818
4 Seats	Hatch	1984-93	2	C4825
To 01/1989; 2 Seats	Hatch	1984-89	2	C4727
To 01/1989	Hood	1984-89	2	E4603
310				
Hatchback	Hatch	1980-82	2	C4730
Left; GX	Hatch	1979-82	1	A4942
Right; GX	Hatch	1979-82	1	A4941
350Z				
Convertible	Deck Lid	2004-09	2	F6564
From 05/2003	Hatch	2003-09	2	D4194
370Z				
	Hatch	2009-16	2	D6674
510				
4-Door	Hatch	1978-81	2	C4728
Almera				
MEX	Hatch	2001-05	2	D6639
Altima				
	Trunk Lid	2008-13	2	F6833
Armada				
	Hood	2017-20	2	D7105
with Power Lift Gate	Liftgate, Gas Charged	2017-19	2	D7122
	Back Glass	2005-15	2	D6612
	Hood	2005-15	2	E4182
with Power Lift Gate	Liftgate, Gas Charged	2005-15	1	C6445
without Power Lift Gate	Liftgate	2005-15	1	C6295
B210				
	Hatch	1974-78	2	C4729
Juke				
To 08/2016	Hatch	2011-17	2	C7003
March				
MEX	Hatch	2012-15	2	D6884
Maxima				
	Hood	2009-14	2	E6478
	Trunk Lid	2009-14	2	F6479
	Trunk Lid	2004-08	2	F4078

GAS CHARGED LIFT SUPPORTS ARE DESIGNED TO BE USED EXCLUSIVELY FOR THE PURPOSE SPECIFIED IN APPLICATION CHARTS. Tech Support 1-888-565-9632

MAKE & MODEL	LOCATION	YEAR	QTY	PART
Nissan (cont.)				
Maxima (cont.)				
	Hood	2004-06	2	E4162
	Hood	2000-03	2	D4161
	Hood	1995-99	2	E4524
Left	Hood	1989-94	1	D4913
Right	Hood	1989-94	1	D4914
	Hood	1985-88	2	B4786
Wagon; 4-Door	Tailgate	1985-88	2	B4824
Murano				
	Hood	2015-22	2	E7094
	Hood	2009-14	2	E6176
without Power Lift Gate	Liftgate	2009-14	2	D6177
	Liftgate	2005-07	2	D6122
	Hood	2003-07	2	E6328
	Liftgate	2003-04	2	D6121
NV1500				
	Hood	2012-21	2	F6645
NV2500				
	Hood	2012-21	2	F6645
NV3500				
	Hood	2012-21	2	F6645
NX				
	Hatch	1991-93	2	D4510
Pathfinder				
Except Power Lift Gate; To 01/2017	Liftgate	2013-17	2	C7015
	Back Glass	2005-12	2	E6607
	Hatch	2005-12	2	D6110
From 12/1998	Back Glass	1999-04	2	D6192
	Hatch	1996-04	2	C4321
To 12/1998	Back Glass	1996-99	2	D4320
Left	Back Glass	1987-95	1	D4815
Right	Back Glass	1987-95	1	D4816
From 07/1986	Liftgate	1987-95	2	C4758
Pathfinder Armada				
	Back Glass	2004	2	D6612
	Hood	2004	2	E4182
	Liftgate	2004	1	C6295
Pulsar NX				
	Hatch	1987-90	2	D4459
Left	Hatch	1983-86	1	B4934
Right	Hatch	1983-86	1	B4933
Quest				
without Power Lift Gate	Liftgate	2011-17	2	B6780
with Power Lift Gate	Liftgate, Gas Charged	2011-13	2	C4589
with Power Lift Gate	Liftgate, Gas Charged	2004-09	2	C4589
	Back Glass	1999-02	2	D4356
with Flip Window	Liftgate	1999-02	2	C4555

MAKE & MODEL	LOCATION	YEAR	QTY	PART
Nissan (cont.)				
Quest (cont.)				
without Flip Window	Liftgate	1999-02	2	C4556
	Liftgate	1996-98	2	C4202
	Back Glass	1993-98	2	D4645
Except Cold Spec	Liftgate	1993-95	2	C4202
Rogue				
	Liftgate	2008-13	2	D6269
Rogue Select				
	Liftgate	2014-15	2	D6269
Sentra				
	Trunk Lid	2007-12	1	F6429
Coupe; 2-Door; SE; without Rear Wiper	Hatch	1987-90	2	A4851
Coupe; 2-Door; XE; without Rear Wiper	Hatch	1987-90	2	A4851
Wagon; 4-Door	Tailgate	1986-89	2	A4899
	Hatch	1982-86	2	C4812
Wagon; 4-Door	Tailgate	1982-85	2	A4852
Stanza				
Left; Wagon; 4-Door; XE; From 03/1985	Tailgate	1986-88	2	B4915
Right; Wagon; 4-Door; XE; From 03/1985	Tailgate	1986-88	1	B4916
	Hatch	1982-87	2	C4751
Left; Hatchback; To 08/1984	Hatch	1982-84	1	C4747
Right; Hatchback; To 08/1984	Hatch	1982-84	1	C4746
Tiida				
Left	Hatch	2008-12	1	D6490L
Right	Hatch	2008-12	1	D6490R
Titan				
	Hood	2004-15	2	E4182
	Tailgate	2004-15	2	E6694
Urvan				
Left; MEX	Liftgate	2000-13	1	A7010
Versa				
Left	Hatch	2007-12	1	D6490L
Right	Hatch	2007-12	1	D6490R
Versa Note				
	Hatch	2014-19	2	C6871
Xterra				
	Hatch	2005-15	2	D6137
	Top Stowage Compartment	2005-15	2	E6911
	Hatch	2001-04	2	C4375
Left	Liftgate	2000	1	C6119L
Right	Liftgate	2000	1	C6119R
X-Trail				
MEX	Hatch	2008-13	2	C6747
	Liftgate	2002-07	2	D6640

GAS CHARGED LIFT SUPPORTS ARE DESIGNED TO BE USED EXCLUSIVELY FOR THE PURPOSE SPECIFIED IN APPLICATION CHARTS.

Tech Support 1-888-565-9632

APPLICATION GUIDE / GUÍA DE APLICACIONES / GUIDE D'APPLICATIONS



MAKE & MODEL	LOCATION	YEAR	QTY	PART
Oldsmobile				
88				
	Hood	1992-99	2	D4627
98				
	Hood	1991-96	2	D4627
	Hood	1985-90	2	E4444
Sedan; 4-Door	Trunk Lid	1979-85	2	F4002
Achieva				
	Hood	1992-98	2	D4629
Alero				
	Hood	1999-01	2	D4332
Aurora				
	Hood	2001-03	2	C4336
	Hood	1995-99	2	A4965
	Trunk Lid	1995-99	2	D4957
Bravada				
	Back Glass	2002-04	2	C4576
	Hatch	2002-04	2	C4573
with Liftgate; with Steel Liftgate	Hatch	2000-01	2	C4287
with Aluminum Liftgate	Liftgate	2000-01	2	C6101
with Dropgate	Tailgate	2000-01	2	F4531
with Liftgate	Back Glass	1997-01	2	C4799
with Dropgate	Back Glass	1996-01	1	D4316
with Liftgate	Hatch	1997-99	2	C4287
with Dropgate	Tailgate	1996-98	2	F4531
with Rear Defroster	Back Glass	1991-94	2	D4451
Custom Cruiser				
Wagon; 4-Door	Back Glass	1991-92	2	D4762
	Hood	1991-92	2	C4755
Wagon; 4-Door	Back Glass	1978-83	2	D4404
Cutlass				
	Hood	1995-99	2	D4629
Coupe; 2-Door; Except Ciera	Trunk Lid	1980-81	2	F4100
Sedan; 4-Door; Except Ciera	Trunk Lid	1980-81	2	F4002
Cutlass Calais				
	Hood	1988-91	2	D4496
Cutlass Ciera				
Wagon; 4-Door	Hatch	1991-96	2	C4776
	Back Glass	1986-96	2	D4447
Wagon; 4-Door	Hatch	1984-86	2	C4776
Cutlass Cruiser				
	Back Glass	1987-94	2	D4447
Wagon; 4-Door	Hatch	1987-94	2	C4776
Cutlass Salon				
Coupe; 2-Door; Except Ciera	Trunk Lid	1979-80	2	F4100
Sedan; 4-Door; Except Ciera	Trunk Lid	1979-80	2	F4002
Cutlass Supreme				
	Hood	1993-97	2	C4463
	Hood	1988-92	2	D4496

MAKE & MODEL	LOCATION	YEAR	QTY	PART
Oldsmobile (cont.)				
Delta 88				
	Hood	1986-91	2	E4444
	Trunk Lid	1979-85	2	F4002
Firenza				
Wagon; 4-Door	Tailgate	1983-88	2	C4708
	Hatch	1982-88	2	A4901
Intrigue				
2nd Design; without Spoiler	Trunk Lid	1999-02	2	E6413
	Hood	1998-02	2	C4295
1st Design; without Spoiler	Trunk Lid	1998-99	2	E4521
LSS				
	Hood	1996-99	2	D4627
Omega				
with Spoiler	Trunk Lid	1980-84	2	F4004
without Spoiler	Trunk Lid	1980-84	2	F4000
	Hatch	1975-79	2	C4701
Regency				
	Hood	1997-98	2	D4627
Silhouette				
	Liftgate	1997-04	2	B4304
	Hatch	1995-96	1	B4849
	Liftgate	1992-96	2	B4855
	Hatch	1990-91	2	B4787
Starfire				
	Hatch	1975-80	2	D4411
Toronado				
	Hood	1986-92	2	B4744
Except Aluminum Hood; From 1983; To 1985	Hood	1979-85	2	E4417
	Trunk Lid	1979-83	2	F4101
Peugeot				
206				
MEX	Hatch	2004-09	2	D6538
Hatchback; 4-Door; MEX	Tailgate	2004-09	2	C6537
307				
MEX	Hatch	2003-09	2	D6748
505				
with Spoiler	Trunk Lid	1989-91	2	D6266
	Hatch	1984-91	2	C4784
Plymouth				
Arrow				
	Hatch	1980	2	C4713
Breeze				
	Trunk Lid	1996-00	2	E4477
Champ				
	Hatch	1979-82	2	C4713
Colt				
Left	Hatch	1989-95	1	C4961L
Right	Hatch	1989-95	1	C4961R
Wagon; 4-Door	Hatch	1985-91	2	B4733

GAS CHARGED LIFT SUPPORTS ARE DESIGNED TO BE USED EXCLUSIVELY FOR THE PURPOSE SPECIFIED IN APPLICATION CHARTS. Tech Support 1-888-565-9632

MAKE & MODEL	LOCATION	YEAR	QTY	PART
Plymouth (cont.)				
Grand Voyager				
	Hatch	1996-00	2	B4865
with Spoiler; with Wiper	Liftgate	1991-95	2	C4837
without Spoiler; without Wiper	Liftgate	1991-95	2	C4834
Horizon				
without Spoiler	Hatch	1979-90	2	D4618
with Spoiler	Hatch	1980-87	2	D4400
with Spoiler & Louvers	Hatch	1980-87	2	D4688
with Spoiler	Hatch	1979	2	D4401
Laser				
	Hatch	1990-94	2	C4731
Prowler				
Convertible; 2-Door	Deck Lid	1999-01	2	E4959
	Hood	1999-01	2	F4032
Convertible; 2-Door	Deck Lid	1997	2	E4959
Reliant				
Wagon; 4-Door	Hatch	1981-89	2	D4442
Sundance				
with Spoiler	Hatch	1987-94	2	D4449
without Spoiler	Hatch	1987-94	2	D4490
TC3				
with Spoiler & Louvers	Hatch	1980-82	2	D4688
Trailduster				
	Hatch	1981	2	C4775
	Hatch	1974-80	2	E4441
Turismo				
with Spoiler & Louvers	Hatch	1983-87	2	D4688
with Spoiler	Hatch	1983-85	2	D4400
without Spoiler	Hatch	1983-85	2	D4618
Volare				
Wagon; 4-Door; Eyelets on Both Ends; From 12/1976	Tailgate	1976-80	2	D4409
Voyager				
	Hatch	1996-00	2	B4865
with Wiper	Liftgate	1991-95	2	C4837
without Spoiler; without Wiper	Liftgate	1991-95	2	C4834
without Rear Wiper	Hatch	1984-90	2	C4775
Pontiac				
6000				
	Back Glass	1984-91	2	D4447
Wagon; 4-Door	Hatch	1984-91	2	C4776
Astre				
Wagon; 2-Door	Tailgate	1976-77	2	C4717
Aztek				
	Back Glass	2001-05	2	D4353
	Hood	2001-05	2	E4131
with Droptgate	Tailgate	2001-05	2	F6529
Bonneville				
2nd Design	Hood	2005	1	C6595

MAKE & MODEL	LOCATION	YEAR	QTY	PART
Pontiac (cont.)				
Bonneville (cont.)				
1st Design	Hood	2000-05	2	C4336
	Hood	1992-99	2	D4627
	Hood	1987-91	2	E4444
Wagon; 4-Door	Back Glass	1982-83	2	D4404
	Trunk Lid	1979-81	2	F4002
Catalina				
	Trunk Lid	1979-81	2	F4002
Firebird				
	Hood	1998-02	2	D4543
Rear; Convertible	Deck Lid	1994-02	2	E4529
with Spoiler	Hatch	1993-02	2	B4897
without Spoiler	Hatch	1993-02	2	B6268
	Hood	1993-97	2	D4636
Rear; Convertible	Deck Lid	1991-92	2	E4632
with Spoiler; with Wiper	Hatch	1982-92	2	A4900
without Spoiler; without Wiper	Hatch	1982-92	2	A4967
with Fiberglass Hood	Hood	1982-92	2	E4134
with Steel Hood	Hood	1982-92	2	E4422
Rear; Convertible	Deck Lid	1989	2	E4632
Firefly				
Left	Hatch	1994	1	C4827
Right	Hatch	1994	1	C4826
Left	Hatch	1990-91	1	C4827
Right	Hatch	1990-91	1	C4826
	Hatch	1985-88	2	C4724
G3				
	Hatch	2009-10	2	E6500
G5				
	Hood	2007-09	2	C6321
	Trunk Lid	2007-09	2	E6409
G6				
	Trunk Lid	2005-10	2	E6412
Convertible	Deck Lid	2006-09	2	F6774
G8				
	Hood	2008-09	2	D6557
with Spoiler	Trunk Lid	2008-09	2	E6556
Grand LeMans				
Wagon; 4-Door	Back Glass	1980-81	2	D4404
Coupe; 2-Door	Trunk Lid	1980-81	2	F4100
Grand Prix				
2nd Design	Hood	2005-08	2	C6331
with Spoiler	Trunk Lid	2004-08	2	E4072
1st Design	Hood	2005	2	C6315
	Hood	2004	2	D4152
	Hood	1997-03	2	C4295
2nd Design; with Spoiler	Trunk Lid	1997-03	2	E4082
1st Design; with Spoiler	Trunk Lid	1997-99	2	E4112

GAS CHARGED LIFT SUPPORTS ARE DESIGNED TO BE USED EXCLUSIVELY FOR THE PURPOSE SPECIFIED IN APPLICATION CHARTS. Tech Support 1-888-565-9632

APPLICATION GUIDE / GUÍA DE APLICACIONES / GUIDE D'APPLICATIONS



MAKE & MODEL	LOCATION	YEAR	QTY	PART
Pontiac (cont.)				
Grand Prix (cont.)				
	Hood	1993-96	2	C4463
	Hood	1988-92	2	D4496
Coupe; 2-Door	Trunk Lid	1981-82	2	F4100
Grand Safari				
Wagon; 4-Door	Back Glass	1978	2	D4404
GTO				
	Hood	2004-06	2	C4097
	Trunk Lid	2004-06	2	F6434
J2000				
	Hatch	1982-83	2	A4901
Wagon; 4-Door	Tailgate	1982-83	2	C4708
J2000 Sunbird				
	Hatch	1984-85	2	A4901
LeMans				
	Hatch	1988-93	2	C4750
Coupe; 2-Door	Trunk Lid	1980-81	2	F4100
Wagon; 4-Door; Safari	Back Glass	1978-81	2	D4404
Montana				
	Liftgate	1999-06	2	B4304
Parisienne				
Sedan; 4-Door	Trunk Lid	1983	2	F4002
Phoenix				
with Spoiler	Trunk Lid	1981-84	2	F4004
	Hatch	1980-84	2	D4411
without Spoiler	Trunk Lid	1980-84	2	F4000
	Hatch	1978-79	2	C4701
Pursuit				
CAN	Hood	2005-06	2	C6321
CAN	Trunk Lid	2005-06	2	E6409
Solstice				
	Hood	2006-09	2	D6357
Sunbird				
	Hatch	1986-87	2	A4901
with Rear Defroster	Hatch	1977-80	2	D4411
without Rear Defroster	Hatch	1977-80	2	C4445
Sunburst				
	Hatch	1985-88	2	C4452
Sunfire				
Convertible; 2-Door	Deck Lid	1995-00	2	E4113
T1000				
	Hatch	1981-87	2	D4411
Tempest				
without Electrical End Fittings	Trunk Lid	1989-91	2	B4962
Torrent				
	Hood	2006-09	2	D6325
	Liftgate	2006-09	2	C6108
Trans Sport				
	Liftgate	1997-99	2	B4304
	Liftgate	1992-96	2	B4855

MAKE & MODEL	LOCATION	YEAR	QTY	PART
Pontiac (cont.)				
Trans Sport (cont.)				
	Hatch	1990-91	2	B4787
Ventura				
	Hatch	1975-77	2	C4701
Vibe				
	Hatch	2009-10	2	E6480
	Back Glass	2003-08	2	D6606
	Hatch	2003-08	2	D4079
Wave				
CAN	Hatch	2005-08	2	E6500
Porsche				
911				
Convertible; Turbo S	Hood	2011-13	2	F6364
Coupe; Turbo S	Hood	2011-13	2	F6364
997 Body; Turbo S	Trunk Lid	2011-13	2	E6528
Convertible; Turbo	Hood	2007-13	2	F6364
Coupe; Turbo	Hood	2007-13	2	F6364
997 Body; Turbo	Trunk Lid	2007-13	2	E6528
Convertible; Carrera 4	Hood	2006-13	2	F6364
Coupe; Carrera 4	Hood	2006-13	2	F6364
Convertible; Carrera S	Hood	2005-13	2	F6364
Coupe; Carrera S	Hood	2005-13	2	F6364
Convertible; Carrera 4S	Hood	2002-13	2	F6364
Coupe; Carrera 4S	Hood	2002-13	2	F6364
Convertible; Carrera	Hood	1999-13	2	F6364
Coupe; Carrera	Hood	1999-13	2	F6364
997 Body; Carrera 4 GTS	Trunk Lid	2012	2	E6528
997 Body; Carrera GTS	Trunk Lid	2011-12	2	E6528
997 Body; Targa 4	Trunk Lid	2007-12	2	E6528
997 Body; Targa 4S	Trunk Lid	2007-12	2	E6528
997 Body; Carrera 4	Trunk Lid	2006-12	2	E6528
997 Body; Carrera 4S	Trunk Lid	2006-12	2	E6528
997 Body; Carrera	Trunk Lid	2005-12	2	E6528
997 Body; Carrera S	Trunk Lid	2005-12	2	E6528
997 Body; GT2 RS	Trunk Lid	2011	2	E6528
997 Body; GT3 RS	Trunk Lid	2011	2	E6528
997 Body; GT3 RS 4.0	Trunk Lid	2011	2	E6528
Coupe; GT3	Hood	2010-11	2	F6364
997 Body; GT3	Trunk Lid	2010-11	2	E6528
Coupe; GT2	Hood	2008-11	2	F6364
997 Body; GT2	Trunk Lid	2008-09	2	E6528
Coupe; GT3	Hood	2007-08	2	F6364
997 Body; GT3	Trunk Lid	2007-08	2	E6528
997 Body; GT3 RS	Trunk Lid	2007-08	2	E6528
Convertible; Turbo S	Hood	2005	2	F6364
Coupe; Turbo S	Hood	2005	2	F6364
Coupe; GT3	Hood	2004-05	2	F6364

GAS CHARGED LIFT SUPPORTS ARE DESIGNED TO BE USED EXCLUSIVELY FOR THE PURPOSE SPECIFIED IN APPLICATION CHARTS. Tech Support 1-888-565-9632

MAKE & MODEL	LOCATION	YEAR	QTY	PART
Porsche (cont.)				
911 (cont.)				
Coupe; GT2	Hood	2002-05	2	F6364
Convertible; Turbo	Hood	2001-05	2	F6364
Coupe; Turbo	Hood	2001-05	2	F6364
Convertible; Carrera 4	Hood	2004	2	F6364
Coupe; Carrera 4	Hood	2004	2	F6364
Carrera 4	Hood	2003	2	F6597
Convertible; Carrera 4	Hood	1999-02	2	F6364
Coupe; Carrera 4	Hood	1999-02	2	F6364
Coupe; GT3	Hood	2001	2	F6364
Coupe; Carrera S	Hood	1998	2	F4052
Coupe; Carrera 4S	Hood	1996-98	2	F4052
Front; Carrera 4S	Trunk Lid	1996-98	2	E4047
Convertible; Carrera	Hood	1995-98	2	F4052
Convertible; Carrera 4	Hood	1995-98	2	F4052
Coupe; Carrera	Hood	1995-98	2	F4052
Front; Carrera 4	Trunk Lid	1989-98	2	E4047
Convertible; Carrera 2	Hood	1996	2	F4052
Coupe; Carrera 2	Hood	1996	2	F4052
Convertible; Carrera 2	Hood	1990-94	2	F4052
Coupe; Carrera 2	Hood	1990-94	2	F4052
Front; Carrera 2	Trunk Lid	1990-94	2	E4047
Coupe; Carrera 4	Hood	1989-94	2	F4052
Convertible; Carrera 4	Hood	1990-93	2	F4052
Convertible; Turbo Carrera	Hood	1989	2	F4052
Coupe; Turbo Carrera	Hood	1989	2	F4052
with Lid	Trunk Lid	1968-88	2	E4454
Rear; with Spoiler	Hood	1965-88	2	F4034
Rear; without Spoiler	Hood	1965-88	2	F4006
912				
Rear; with Spoiler	Hood	1976	2	F4034
Rear; without Spoiler	Hood	1976	2	F4006
From 07/1968	Trunk Lid	1976	2	E4454
From 07/1968	Trunk Lid	1968-69	2	E4454
Rear; with Spoiler	Hood	1965-69	2	F4034
Rear; without Spoiler	Hood	1965-69	2	F4006
924				
	Hatch	1987-88	2	C4278
	Hood	1987-88	2	E4469
	Hood	1977-82	2	E4469
928				
GTS	Hatch	1993-95	2	D4652
GTS	Hood	1993-95	2	D4651
Base	Hatch	1990-91	2	D4652
GT	Hatch	1990-91	2	D4652
Base	Hood	1990-91	2	D4651
GT	Hood	1990-91	2	D4651

MAKE & MODEL	LOCATION	YEAR	QTY	PART
Porsche (cont.)				
928 (cont.)				
S4	Hatch	1987-89	2	D4652
S4	Hood	1987-89	2	D4651
S	Hatch	1983-86	2	D4652
S	Hood	1983-86	2	D4651
Base	Hatch	1978-82	2	D4652
Base	Hood	1978-82	2	D4651
930				
Rear; with Spoiler	Hood	1978-79	2	F4034
Rear; without Spoiler	Hood	1978-79	2	F4006
	Trunk Lid	1978-79	2	E4454
944				
Convertible	Deck Lid	1989-91	2	E4330
Coupe	Hatch	1989-91	2	C4278
Coupe	Hood	1983-91	2	D4631
968				
Convertible	Deck Lid	1992-95	2	E4330
Coupe	Hatch	1992-95	2	C4278
	Hood	1992-95	2	F4033
Boxster				
	Trunk Lid	1999-12	2	E6528
Convertible; 2-Door	Deck Lid	1997-09	2	F6281
Carrera GT				
Rear Engine	Deck Lid	2004-06	2	C7036
Cayenne				
; with Power Lift Gate	Power Liftgate	2011-16	2	PG5018
	Hood	2008-12	2	C6598
	Back Glass	2008-10	2	F6835
	Back Glass	2003-06	2	F6835
	Hood	2003-06	2	C6598
Cayman				
without aero kit	Hood	2006-12	2	C7038
Panamera				
with Power Lift Gate	Power Liftgate	2010-16	2	PG5017
Ram				
1500				
	Hood	2011-18	2	D6659
1500 Classic				
	Hood	2019-21	2	D6659
2500				
	Hood	2015-18	2	D7018
with Heavy Duty Cooling	Hood	2012-14	2	D6659
with Standard Duty Cooling	Hood	2012-14	2	D7018
	Hood	2011	2	D7018
3500				
	Hood	2011-18	2	D7018
4500				
	Hood	2011-18	2	D7018

GAS CHARGED LIFT SUPPORTS ARE DESIGNED TO BE USED EXCLUSIVELY FOR THE PURPOSE SPECIFIED IN APPLICATION CHARTS.

Tech Support 1-888-565-9632

APPLICATION GUIDE / GUÍA DE APLICACIONES / GUIDE D'APPLICATIONS

MAKE & MODEL	LOCATION	YEAR	QTY	PART
Ram (cont.)				
5500				
	Hood	2011-18	2	D7018
C/V				
with Power Lift Gate	Liftgate, Gas Charged	2012-15	2	C6124
without Power Lift Gate	Liftgate	2012-15	2	C6257
Dakota				
	Hood	2011	2	E6558
Renault				
Alliance				
	Hatch	1983-87	2	D4455
Clio				
MEX	Hatch	2002-10	2	D6749
Encore				
	Hatch	1984-86	2	D4455
Kangoo Express				
MEX	Hatch	2004-14	2	D6750
Saab				
900				
Hatchback; with Wiper	Hatch	1994-98	2	C4879
Hatchback; without Wiper	Hatch	1994-98	2	C4880
	Hood	1994-98	2	D4255
with Spoiler	Hatch	1979-93	2	D4670
without Spoiler	Hatch	1979-93	2	D4460
9000				
with Rear Wiper	Hatch	1997-98	1	D6579
without Rear Wiper	Hatch	1997-98	2	D6512
	Hood	1986-98	2	C4760
	Hatch	1994-96	2	D6579
Aero; with Spoiler	Hatch	1993	1	B4876
Aero; without Spoiler	Hatch	1993	1	B4877
CSE Turbo; with Spoiler	Hatch	1993	1	B4876
CSE Turbo; without Spoiler	Hatch	1993	1	B4877
CSE; with Spoiler	Hatch	1993	1	B4876
CSE; without Spoiler	Hatch	1993	1	B4877
S; with Spoiler	Hatch	1991-92	1	B4876
S; without Spoiler	Hatch	1991-92	1	B4877
Turbo; with Spoiler	Hatch	1991-92	1	B4876
Turbo; without Spoiler	Hatch	1991-92	1	B4877
Base; with Spoiler	Hatch	1991	1	B4876
Base; without Spoiler	Hatch	1991	1	B4877
S; with Spoiler	Hatch	1988-90	2	B4876
S; without Spoiler	Hatch	1988-90	2	B4877
	Hatch	1986	2	C4764
9-3				
Convertible; 2-Door	Deck Lid	2004-11	2	E6274
9440 Body	Hood	2004-11	1	B6567
Arc	Hood	2003	1	B6567
Linear	Hood	2003	1	B6567

MAKE & MODEL	LOCATION	YEAR	QTY	PART
Saab (cont.)				
9-3 (cont.)				
SE	Hood	2003	1	C6337
Vector	Hood	2003	1	B6567
Convertible; 2-Door	Deck Lid	1999-03	2	E4144
with Spoiler	Trunk Lid	1999-03	2	F6740
	Hood	2001-02	1	C6337
Convertible; 2-Door; SE; with Spoiler; with Wiper	Hatch	1999-02	2	C4586
Hatchback; 2-Door; Viggen	Hatch	1999-02	2	C6638
	Hood	1999-00	2	C4380
9-3X				
9440 Body	Hood	2010-11	1	B6567
9-5				
	Hood	2006-09	2	C7151
	Hatch	1999-09	2	E6383
Sedan; 4-Door	Trunk Lid	1999-09	2	E6143
	Deck Lid	1999-05	2	B4800
9-7x				
	Back Glass	2005-09	1	C4576
	Hatch	2005-09	1	C4573
99				
with Spoiler	Hatch	1969-80	2	D4670
without Spoiler	Hatch	1969-80	2	D4460
Saturn				
Astra				
	Hood	2008-09	1	C7042
Aura				
	Hood	2008-09	1	D6166
	Trunk Lid	2007-09	2	E6171
	Hood	2007	1	D6353
L300				
Wagon; 4-Door	Hatch	2004	2	C4879
LW1				
Wagon; 4-Door	Hatch	2000	2	C4879
LW2				
Wagon; 4-Door	Hatch	2000	2	C4879
LW200				
Wagon; 4-Door	Hatch	2001-03	2	C4879
LW300				
Wagon; 4-Door	Hatch	2001-03	2	C4879
Outlook				
	Hood	2007-10	1	C7135
	Liftgate	2007-10	2	C6152
Relay				
1	Back Glass	2007	2	D4575
2	Back Glass	2005-07	2	D4575
3	Back Glass	2005-07	2	D4575
	Liftgate	2005-07	2	B4304

GAS CHARGED LIFT SUPPORTS ARE DESIGNED TO BE USED EXCLUSIVELY FOR THE PURPOSE SPECIFIED IN APPLICATION CHARTS. Tech Support 1-888-565-9632

MAKE & MODEL	LOCATION	YEAR	QTY	PART
Saturn (cont.)				
Sky				
Convertible; 2-Door	Hood	2007-10	2	D6357
SW1				
Wagon; 4-Door	Hatch	1996-99	2	B4288
Wagon; 4-Door	Tailgate	1993-95	2	B4981
SW2				
Wagon; 4-Door	Hatch	1996-01	2	B4288
Wagon; 4-Door	Tailgate	1993-95	2	B4981
Vue				
	Hood	2008-10	2	D6242
	Liftgate	2008-10	2	C6243
	Hood	2006-07	2	C6144
	Liftgate	2002-07	2	D4363
Scion				
FR-S				
	Trunk Lid	2013-16	2	D6759
tC				
	Hatch	2005-10	2	D4597
xB				
	Liftgate	2008-15	2	D7071
Left; with Wiper	Hatch	2004-06	1	C6206L
Right; with Wiper	Hatch	2004-06	1	C6206R
xD				
	Hatch	2008-14	2	D6011
Seat				
Ibiza				
MEX	Trunk Lid	2003-11	2	D6548
Leon				
MEX	Hatch	2007-09	2	D6824
Toledo				
MEX	Hatch	2005-06	2	A6752
Smart				
Fortwo				
	Back Glass	2005-16	2	D6482
Subaru				
DL				
Left; Wagon; 4-Door	Tailgate	1985-89	1	B4949L
Right; Wagon; 4-Door	Tailgate	1985-89	1	B4949R
	Hatch	1980-84	2	D4434
Wagon; 4-Door	Tailgate	1980-84	2	B4780
Forester				
	Hood	2014-18	2	C6002
Left	Liftgate	2009-13	1	C7074L
Right	Liftgate	2009-13	1	C7074R
Left	Tailgate	2003-05	1	C6219L
Right	Tailgate	2003-05	1	C6219R
Left	Tailgate	1998-99	1	B6220L
Right	Tailgate	1998-99	1	B6220R

MAKE & MODEL	LOCATION	YEAR	QTY	PART
Subaru (cont.)				
GL				
Left; Wagon; 4-Door	Tailgate	1985-89	1	B4949L
Right; Wagon; 4-Door	Tailgate	1985-89	1	B4949R
	Hatch	1980-84	2	D4434
Wagon; 4-Door	Tailgate	1980-84	2	B4780
Impreza				
Wagon; 4-Door	Tailgate	2002-07	2	C6215
with Wiper	Hatch	1998-01	2	C6225
	Hatch	1993-97	2	C6514
Legacy				
	Hood	2010-14	2	D6837
	Trunk Lid	2010-14	2	E6843
Left; Wagon; B13 Body	Tailgate	2005-08	1	C6222L
Right; Wagon; B13 Body	Tailgate	2005-08	1	C6222R
Left; Wagon	Tailgate	1995-04	1	C4221L
Right; Wagon	Tailgate	1995-04	1	C4221R
Left; Wagon; 4-Door	Tailgate	1990-94	1	B4867L
Right; Wagon; 4-Door	Tailgate	1990-94	1	B4867R
Loyale				
Left; Wagon; 4-Door	Tailgate	1990-94	1	B4949L
Right; Wagon; 4-Door	Tailgate	1990-94	1	B4949R
Outback				
	Hood	2010-14	2	D6837
Left; Wagon; B13 Body	Tailgate	2005-09	1	C6222L
Right; Wagon; B13 Body	Tailgate	2005-09	1	C6222R
Left; Wagon	Tailgate	2000-04	1	C4221L
Right; Wagon	Tailgate	2000-04	1	C4221R
Standard				
	Hatch	1980-84	2	D4434
SVX				
	Trunk Lid	1992-97	2	E6226
Suzuki				
Forsa				
CAN	Hatch	1987-88	2	C4724
Grand Vitara				
Rear	Door	2006-13	2	D6173
Rear	Door	1999-05	2	D4560
Reno				
	Hatch	2005-08	2	D6504
Sidekick				
Rear; Japan Built	Door	1992-98	1	C4789
Swift				
Left	Hatch	1995-01	1	B4987L
Right	Hatch	1995-01	1	B4987R
Left	Hatch	1989-94	1	C4827
Right	Hatch	1989-94	1	C4826
XL-7				
	Hatch	2007-09	2	C6174
	Hood	2007-09	2	D6325

GAS CHARGED LIFT SUPPORTS ARE DESIGNED TO BE USED EXCLUSIVELY FOR THE PURPOSE SPECIFIED IN APPLICATION CHARTS. Tech Support 1-888-565-9632

APPLICATION GUIDE / GUÍA DE APLICACIONES / GUIDE D'APPLICATIONS

MAKE & MODEL	LOCATION	YEAR	QTY	PART
Suzuki (cont.)				
XL-7 (cont.)				
Rear	Door	2002-06	1	D4560
Toyota				
4Runner				
	Liftgate	2010-22	2	C6550
	Hood	2010-21	2	D6761
	Hood	2003-09	2	D6228
	Liftgate	2003-09	2	D6107
	Hatch	1996-02	1	C4286
Avalon				
	Hood	2013-18	2	C6757
GSX30 Body	Hood	2005-12	2	C6452
	Hood	2000-04	2	E4159
Left	Hood	1995-99	1	D4549L
Right	Hood	1995-99	1	D4549R
Camry				
	Hood	2018-21	2	C7170
	Hood	2012-17	2	C6757
	Hood	2007-11	2	B6333
	Hood	2002-06	1	B4171
Japan Built	Hood	2000-01	2	D4547
USA Built	Hood	1997-01	2	E4326
Left; Wagon; 4-Door	Tailgate	1992-96	1	C4951L
Right; Wagon; 4-Door	Tailgate	1992-96	1	C4951R
Left	Hood	1991-96	1	D4217L
Right	Hood	1991-96	1	D4217R
Left; Wagon; 4-Door	Tailgate	1987-91	1	C4963L
Right; Wagon; 4-Door	Tailgate	1987-91	1	C4963R
	Hatch	1983-84	2	B4753
Celica				
Left; GT; with Rear Wiper; with Large Spoiler	Hatch	2000-05	1	D6191L
Left; GT; with Rear Wiper; without Spoiler	Hatch	2000-05	1	D6146L
Left; GTS; with Large Spoiler	Hatch	2000-05	1	D6191L
Left; GTS; without Spoiler	Hatch	2000-05	1	D6146L
Left; with Small Spoiler	Hatch	2000-05	1	D6509L
Right; GT; with Rear Wiper; with Large Spoiler	Hatch	2000-05	1	D6191R
Right; GT; with Rear Wiper; without Spoiler	Hatch	2000-05	1	D6146R
Right; GT; with Small Spoiler	Hatch	2000-05	1	D6509R
Right; GTS; with Large Spoiler	Hatch	2000-05	1	D6191R
Right; GTS; with Small Spoiler	Hatch	2000-05	1	D6509R
Right; GTS; without Spoiler	Hatch	2000-05	1	D6146R
with Spoiler; with Wiper	Hatch	2000-05	2	D4196
GT	Trunk Lid	1995-99	2	C4680
Left; with Spoiler	Hatch	1994-99	1	C4955L

MAKE & MODEL	LOCATION	YEAR	QTY	PART
Toyota (cont.)				
Celica (cont.)				
Right; with Spoiler	Hatch	1994-99	1	C4955R
ST	Trunk Lid	1995-97	2	C4680
Left	Hatch	1990-93	1	B4930
Right	Hatch	1990-93	1	B4929
without Spoiler	Trunk Lid	1990-93	2	D4654
with Spoiler	Trunk Lid	1986-93	2	D4619
Left; From 08/1985; To 08/1987	Hatch	1985-87	1	C4906
Right; GT; From 08/1985; To 08/1987	Hatch	1985-87	1	C4905
Right; GTS; From 08/1985; To 08/1987	Hatch	1985-87	1	C4905
Right; ST; From 08/1985; To 08/1987	Hatch	1985-87	1	C4905
Supra	Hood	1986	2	E4604
Convertible; GTS	Deck Lid	1984-85	2	F4474
with Rear Wiper	Hatch	1976-85	2	C4702
without Rear Wiper	Hatch	1976-85	2	C4703
Supra	Hood	1982-84	2	E4604
Corolla				
Left; Wagon; 5-Door; DX; with Rear Wiper	Tailgate	1993-96	1	C4305L
Right; Wagon; 5-Door; DX; with Rear Wiper	Tailgate	1993-96	1	C4305R
FX; To 09/1988	Hatch	1987-88	2	C4763
Coupe; with Rear Wiper	Hatch	1976-86	2	C4702
Coupe; without Rear Wiper	Hatch	1976-86	2	C4262
Hatchback; with Rear Wiper	Hatch	1976-86	2	C4702
Hatchback; without Rear Wiper	Hatch	1976-86	2	C4262
Wagon; without Rear Wiper	Hatch	1979-83	2	C4703
Cressida				
Left	Hood	1989-92	1	D4156L
Right	Hood	1989-92	1	D4156R
Left	Hood	1984-88	1	D4605
Right	Hood	1984-88	1	D4606
Wagon; 4-Door	Tailgate	1985-87	2	B4838
FJ Cruiser				
	Hood	2011-14	2	D6855
	Back Glass	2007-14	2	D6613
	Hood	2007-10	2	D6355
Highlander				
Hybrid LE	Back Glass	2014-19	2	E7032
Hybrid Limited	Back Glass	2014-19	2	E7032
Hybrid XLE	Back Glass	2014-19	2	E7032
LE	Back Glass	2014-19	2	E7032
LE Plus	Back Glass	2014-19	2	E7032
Limited	Back Glass	2014-19	2	E7032

GAS CHARGED LIFT SUPPORTS ARE DESIGNED TO BE USED EXCLUSIVELY FOR THE PURPOSE SPECIFIED IN APPLICATION CHARTS. Tech Support 1-888-565-9632

MAKE & MODEL	LOCATION	YEAR	QTY	PART
Toyota (cont.)				
Highlander (cont.)				
XLE	Back Glass	2014-19	2	E7032
without Power Lift Gate	Liftgate	2014-19	2	C7040
	Back Glass	2012-13	2	D6264
with Power Lift Gate	Liftgate, Gas Charged	2008-13	2	D6762
Except Japan Built	Back Glass	2008-11	2	D6264
	Liftgate	2001-07	2	D4598
Land Cruiser				
Left	Hatch	1998-07	1	D4362L
Right	Hatch	1998-07	1	D4362R
	Hood	1998-07	2	D4361
Left	Hatch	1991-97	1	D6741L
Right	Hatch	1991-97	1	D6741R
Left	Hood	1990-97	1	D4551L
Right	Hood	1990-97	1	D4551R
From 11/1980	Tailgate	1981-91	2	D4526
Left	Hatch	1990	1	D6781L
Right	Hatch	1990	1	D6781R
Matrix				
with Rear Wiper	Hatch	2009-14	2	D7133
Wagon; 4-Door	Back Glass	2003-08	2	D4188
Wagon; 4-Door	Tailgate	2003-08	2	D6204
Previa				
Left	Hatch	1991-97	1	B4918
Right	Hatch	1991-97	1	B4917
Prius				
From 04/2012	Hatch	2012-15	2	D7088
To 04/2012	Hatch	2010-12	2	D6244
	Hatch	2004-09	2	D4094
Prius Plug-In				
From 04/2012	Hatch	2012-15	2	D7088
To 04/2012	Hatch	2012	2	D6244
RAV4				
To 10/2015	Hatch	2013-16	2	D6842
Sequoia				
with Power Lift Gate	Hatch	2008-21	2	C6656
without Power Lift Gate	Liftgate	2008-21	2	C6688
	Hood	2008-18	2	B6655
Replaces 7030	Hood	2001-07	2	C4379
	Liftgate	2001-07	2	B4995
Sienna				
Limited Premium; with 10 Speaker Stereo System	Liftgate	2018-20	2	C6888
Limited Premium; with 6 Speaker Stereo System	Liftgate	2018-20	2	C6763
Limited; with 6 Speaker Stereo System	Liftgate	2018-20	2	C6763
SE Premium; with 10 Speaker Stereo System	Liftgate	2018-20	2	C6888

MAKE & MODEL	LOCATION	YEAR	QTY	PART
Toyota (cont.)				
Sienna (cont.)				
SE Premium; with 6 Speaker Stereo System	Liftgate	2018-20	2	C6763
SE; with 6 Speaker Stereo System	Liftgate	2018-20	2	C6763
XLE Premium; with 10 Speaker Stereo System	Liftgate	2018-20	2	C6888
XLE Premium; with 6 Speaker Stereo System	Liftgate	2018-20	2	C6763
XLE; with 6 Speaker Stereo System	Liftgate	2018-20	2	C6763
Limited; with 10 Speaker Stereo System	Liftgate	2016-20	2	C6888
SE; with 10 Speaker Stereo System	Liftgate	2016-20	2	C6888
XLE; with 10 Speaker Stereo System	Liftgate	2016-20	2	C6888
Limited; with 6 Speaker Stereo System; with Bluetooth	Liftgate	2011-17	1	C6763
SE; with 6 Speaker Stereo System; with Power Lift Gate; with Bluetooth	Liftgate, Gas Charged	2011-17	2	C6763
XLE; with 6 Speaker Stereo System; with Bluetooth	Liftgate	2011-17	1	C6763
Limited; with 10 Speaker Stereo System; without Power Lift Gate	Liftgate	2011-15	2	C6888
Limited; with 6 Speaker Stereo System; without Bluetooth	Liftgate	2011-15	2	C7131
SE; with 10 Speaker Stereo System; with Power Lift Gate	Liftgate, Gas Charged	2011-15	2	C6888
SE; with 6 Speaker Stereo System; with Power Lift Gate; without Bluetooth	Liftgate, Gas Charged	2011-15	1	C7131
XLE; with 10 Speaker Stereo System; without Power Lift Gate	Liftgate	2011-15	2	C6888
XLE; with 6 Speaker Stereo System; without Bluetooth	Liftgate	2011-15	2	C7131
without Power Lift Gate	Liftgate	2006-10	2	C6140
with Power Lift Gate	Liftgate, Gas Charged	2005-10	2	C4590
From 11/2003	Hatch	2004-05	2	C7014
To 11/2003	Liftgate	1998-03	2	C4994
Solara				
	Hood	2004-08	1	B6466
Left	Hood	1999-03	1	D4174L
Right	Hood	1999-03	1	D4174R
Starlet				
	Hatch	1981-84	2	C4211
Supra				
	Hatch	1986-92	2	C4327
Tercel				
Wagon; 4-Door	Tailgate	1983-88	2	B4805

GAS CHARGED LIFT SUPPORTS ARE DESIGNED TO BE USED EXCLUSIVELY FOR THE PURPOSE SPECIFIED IN APPLICATION CHARTS. Tech Support 1-888-565-9632

APPLICATION GUIDE / GUÍA DE APLICACIONES / GUIDE D'APPLICATIONS

MAKE & MODEL	LOCATION	YEAR	QTY	PART
Toyota (cont.)				
Tercel (cont.)				
	Hatch	1980-86	2	C4779
	Back Glass	1980-82	2	D4431
Tundra				
USK51 Body	Hood	2019-21	2	C7168
USK52 Body	Hood	2019-21	2	C7168
USK57 Body	Hood	2019-21	2	C7168
	Tailgate	2007-21	1	D7066
	Hood	2015-18	2	C7168
From 08/2013	Hood	2014	1	C7168
To 08/2013	Hood	2014	1	B6655
	Hood	2007-13	2	B6655
Replaces 7030	Hood	2000-06	2	C4379
Van				
Left	Liftgate	1984-89	1	B4823
Right	Liftgate	1984-89	1	B4822
Venza				
with Power Lift Gate	Liftgate, Gas Charged	2009-16	2	D6680
Yaris				
	Hatch	2012-17	2	D7136
without Rear Wiper	Hatch	2007-11	2	D7092
with Rear Wiper	Hatch	2006-11	2	D7137
Volkswagen				
Beetle				
with Spoiler	Hatch	2012-19	2	C6733
without Spoiler	Hatch	2012-19	2	C6796
with Spoiler	Hatch	1999-10	2	C4351
without Spoiler	Hatch	1998-10	2	C4325
	Hood	1998-10	1	B4328
Convertible; 2-Door	Deck Lid	2003-08	2	F6425
Cabrio				
	Hood	2000-02	1	D4346
Convertible; 2-Door	Deck Lid	1995-02	2	F6411
Cabriolet				
	Trunk Lid	1985-93	2	D4609
CC				
	Hood	2009-17	2	B6834
	Trunk Lid	2009-17	1	E6851
Corrado				
	Hood	1990-92	2	C6599
Derby				
MEX	Trunk Lid	1995-09	2	E6408
EuroVan				
	Hatch	1999-03	2	C6132
	Hatch	1996-97	2	C6132
Golf				
	Hatch	2014	2	D6275
	Hatch	2010-13	2	D6859
	Hood	2010-13	1	B6001

MAKE & MODEL	LOCATION	YEAR	QTY	PART
Volkswagen (cont.)				
Golf (cont.)				
	Hood	2006-07	1	B6162
GTI 1.8T	Hatch	2006	2	D6163
without Reduced Hatch Opening Angle	Hatch	1999-06	2	D4329
	Hood	1999-05	1	D4346
with Reduced Hatch Opening Angle	Hatch	1999-01	2	D6275
	Hatch	1994-98	2	D4293
with Rear Defroster	Back Glass	1985-95	2	D4405
without Rear Defroster	Back Glass	1985-95	2	D4450
Golf R				
	Hood	2012-13	1	B6001
GTI				
	Hatch	2010-14	1	D6859
	Hood	2010-14	1	B6001
Base	Hatch	2007-09	2	D6163
	Hood	2006-09	1	B6162
Fahrenheit	Hatch	2007	2	D6163
Jetta				
SE Sport	Trunk Lid	2018	2	D6017
Wolfsburg Edition	Trunk Lid	2017-18	2	D6017
Base	Trunk Lid	2013-18	2	D6017
GLI	Trunk Lid	2012-18	2	D6017
S	Trunk Lid	2011-18	2	D6017
SE	Trunk Lid	2011-18	2	D6017
SEL	Trunk Lid	2011-18	2	D6017
Sport	Trunk Lid	2011-18	2	D6017
Trendline	Trunk Lid	2011-18	2	D6017
Hybrid	Trunk Lid	2016	2	D6017
SEL Premium	Trunk Lid	2016	2	D6017
GLI SE	Trunk Lid	2015-16	2	D6017
Hybrid SEL Premium	Trunk Lid	2014-16	2	D6017
TDI S	Trunk Lid	2015	2	D6017
TDI SE	Trunk Lid	2015	2	D6017
TDI SEL	Trunk Lid	2015	2	D6017
Hybrid	Trunk Lid	2013-14	2	D6017
Hybrid Comfortline	Trunk Lid	2013-14	2	D6017
Hybrid Highline	Trunk Lid	2013-14	2	D6017
Hybrid SE	Trunk Lid	2013-14	2	D6017
Hybrid SEL	Trunk Lid	2013-14	2	D6017
Hybrid Trendline	Trunk Lid	2013-14	2	D6017
TDI Premium	Trunk Lid	2012-14	2	D6017
TDI	Trunk Lid	2011-14	2	D6017
	Hood	2010-14	1	B6001
Base	Trunk Lid	2011	2	D6017
Sedan; 4-Door; TDI Cup Edition	Trunk Lid	2010	2	E6430

GAS CHARGED LIFT SUPPORTS ARE DESIGNED TO BE USED EXCLUSIVELY FOR THE PURPOSE SPECIFIED IN APPLICATION CHARTS. Tech Support 1-888-565-9632

MAKE & MODEL	LOCATION	YEAR	QTY	PART
Volkswagen (cont.)				
Jetta (cont.)				
Sedan; 4-Door; S	Trunk Lid	2008-10	2	E6430
Sedan; 4-Door; SE	Trunk Lid	2008-10	2	E6430
Sedan; 4-Door; SEL	Trunk Lid	2008-10	2	E6430
Sedan; 4-Door; Wolfsburg Edition	Trunk Lid	2007-10	2	E6430
Sedan; 4-Door; GLI	Trunk Lid	2006-10	2	E6430
Sedan; 4-Door; TDI	Trunk Lid	2006-10	2	E6430
From Chassis # Vin 1K-5-600-001	Hood	2006-09	1	B6162
Sedan; 4-Door; 2.0T	Trunk Lid	2006-08	2	E6430
Sedan; 4-Door; 2.5	Trunk Lid	2006-08	2	E6430
Sedan; 4-Door; Value Edition	Trunk Lid	2006	2	E6430
Wagon; 4-Door	Hatch	2001-05	2	D4329
To Chassis # Vin 9M-5-149-999	Hood	1999-05	1	D4346
Sedan; 4-Door	Trunk Lid	1999-05	2	E4117
	Trunk Lid	1993-98	2	E4111
	Hatch	1996-97	2	F4035
Lupo				
MEX	Tailgate	2005-09	2	D6819
Passat				
To 01/14/2019	Hood	2019	2	B6808
	Hood	2013-18	2	B6808
To 02/06/2017	Trunk Lid	2012-17	2	E6807
Wagon; 4-Door; Komfort; Except Cold Specification	Hatch	2008-10	2	D6161
	Hood	2006-10	2	B6160
Wagon; 4-Door; VR6	Hatch	2008	2	D6161
Wagon; 4-Door; 3.6	Hatch	2007-08	2	D6161
Wagon; 4-Door; Value Edition	Hatch	2007	2	D6161
Wagon; 4-Door	Hatch	1998-05	2	D4329
	Hood	1998-05	1	B4989
Sedan; 4-Door	Trunk Lid	1998-05	2	E4117
Wagon; 4-Door	Hatch	1996-97	2	D6625
Wagon; 4-Door	Hatch	1990-95	2	D6265
Phaeton				
	Hood	2004-06	2	E6627
without Power Trunk	Trunk Lid	2004-06	2	E6628
Pointer				
MEX	Trunk Lid	2006-09	2	C6498
MEX	Trunk Lid	1998-05	2	C6499
Polo				
MEX	Trunk Lid	2003-07	2	F6535
MEX	Hood	2003-06	2	D6536
Quantum				
Wagon; 4-Door	Tailgate	1987-88	2	C4759
Wagon; 5-Door	Tailgate	1982-86	2	C4759

MAKE & MODEL	LOCATION	YEAR	QTY	PART
Volkswagen (cont.)				
R32				
	Hatch	2008	2	D6163
	Hood	2008	1	B6162
Rabbit				
S	Hatch	2008-09	2	D6163
	Hood	2006-09	1	B6162
2.5	Hatch	2006-07	2	D6163
	Trunk Lid	1982-84	2	D4609
Hatchback	Hatch	1975-84	2	D4442
Scirocco				
with Wiper	Hatch	1982-89	2	D4612
	Hatch	1975-81	2	D4434
Tiguan				
	Hood	2017-20	1	B7123
Except Power Lift Gate	Liftgate	2017-20	2	C7124
	Hatch	2009-17	2	D6467
Tiguan Limited				
	Hatch	2017-18	2	D6467
Touareg				
; with Power Lift Gate	Power Liftgate	2011-17	2	PG5014
	Back Glass	2004-10	2	E6617
	Hood	2004-10	2	D6629
Vanagon				
Standard Passenger Van; 3-Door; Base	Liftgate	1990-91	2	D6247
Standard Passenger Van; 3-Door; Carat	Liftgate	1989-91	2	D6247
Standard Passenger Van; 3-Door; Syncro	Liftgate	1986-91	2	D6247
Van Camper; 3-Door; Campmobile	Liftgate	1984-91	2	D4634
Standard Passenger Van; 3-Door; GL	Liftgate	1982-91	2	D6247
Standard Passenger Van; 3-Door; Bus	Liftgate	1986	2	D6247
Standard Passenger Van; 3-Door; L	Liftgate	1982-86	2	D6247
Campmobile	Hatch	1980-83	2	D4633
Volvo				
145				
	Tailgate	1970-74	1	D4433
1800				
ES	Back Glass	1972-73	2	E6277
245				
	Tailgate	1979-89	2	D4458
Wagon; 4-Door	Tailgate	1975-78	1	D4433
265				
	Tailgate	1979-81	2	D4458
Wagon; 4-Door	Tailgate	1976-78	1	D4433

GAS CHARGED LIFT SUPPORTS ARE DESIGNED TO BE USED EXCLUSIVELY FOR THE PURPOSE SPECIFIED IN APPLICATION CHARTS.

Tech Support 1-888-565-9632

APPLICATION GUIDE / GUÍA DE APLICACIONES / GUIDE D'APPLICATIONS

MAKE & MODEL	LOCATION	YEAR	QTY	PART
Volvo (cont.)				
740				
Wagon; 4-Door	Tailgate	1986-92	2	C4220
with Spoiler	Trunk Lid	1985-92	2	E4335
without Spoiler	Trunk Lid	1985-92	2	E4461
745				
Wagon; 4-Door	Tailgate	1985	2	C4220
GLE	Trunk Lid	1985	2	E4461
760				
with Spoiler	Trunk Lid	1985-90	2	E4335
Wagon; 4-Door	Tailgate	1983-90	2	C4220
without Spoiler	Trunk Lid	1983-90	2	E4461
780				
	Hatch	1987-91	2	E4484
	Tailgate	1987-91	2	C4220
	Trunk Lid	1987-91	2	E4461
850				
Wagon; 4-Door	Hatch	1994-97	2	E4138
	Trunk Lid	1993-97	2	D4669
940				
Wagon; 4-Door	Tailgate	1991-95	2	C4220
with Spoiler	Trunk Lid	1991-95	2	D6435
without Rear Spoiler	Trunk Lid	1991-95	2	D4668
	Hood	1991-93	2	C6346
960				
	Hood	1992-97	2	C6346
Wagon; 4-Door	Tailgate	1992-97	2	C4220
without Rear Spoiler	Trunk Lid	1992-97	2	D4668
C30				
	Hood	2008-13	1	B6630
C70				
	Hood	2006-13	1	B6630
	Trunk Lid	1999-04	2	E6530
S40				
	Hood	2005-11	1	B6630
	Trunk Lid	2005-09	2	E6279
	Hood	2000-04	2	B4988
	Trunk Lid	2000-04	2	E4123
S60				
	Hood	2011-18	2	E6014
	Hood	2001-09	2	F4068
From Chassis # 17910	Trunk Lid	2001-09	2	F6432
S60 Cross Country				
	Hood	2016-18	2	E6014
S70				
with Spoiler	Trunk Lid	1998-00	2	D4334
without Spoiler	Trunk Lid	1998-00	2	D4333
S80				
	Hood	2007-16	2	E7064
	Trunk Lid	2007-16	2	E7065

MAKE & MODEL	LOCATION	YEAR	QTY	PART
Volvo (cont.)				
S80 (cont.)				
	Trunk Lid	2000-06	2	E6631
	Hood	1999-06	2	F4068
S90				
without Rear Spoiler	Trunk Lid	1997-98	2	D4668
V40				
	Hatch	2000-04	2	C6618
	Hood	2000-04	2	B4988
V50				
	Hood	2005-11	1	B6630
	Hatch	2005-09	2	D6632
V60				
	Hood	2015-18	2	E6014
V60 Cross Country				
	Hood	2015-18	2	E6014
V70				
Wagon; 4-Door	Hood	2008-10	2	E7064
	Hatch	2001-07	2	E6278
	Hood	1999-07	2	F4068
	Hatch	1998-00	2	E4138
V90				
	Trunk Lid	1997-98	2	E4461
XC60				
	Hatch	2010-17	2	C6677
	Hood	2010-17	2	F6676
Left; with Power Lift Gate	Power Liftgate	2012-17	1	PG5021L
Right; with Power Lift Gate	Power Liftgate	2012-17	1	PG5021R
XC70				
Wagon; 4-Door	Hood	2008-16	2	E7064
	Hatch	2003-07	2	E6278
	Hood	2003-07	2	F4068
XC90				
	Hatch	2003-14	2	C6133
	Hood	2003-14	2	D6324
Yugo				
GV				
	Hatch	1986	1	C4216

GAS CHARGED LIFT SUPPORTS ARE DESIGNED TO BE USED EXCLUSIVELY FOR THE PURPOSE SPECIFIED IN APPLICATION CHARTS. Tech Support 1-888-565-9632

BUYER'S GUIDE
GUÍA DEL COMPRADOR / GUIDE DE L'ACHETEUR

BUYER'S GUIDE / GUÍA DEL COMPRADOR / GUIDE DE L'ACHETEUR



Part No.	Make/Model	Loc	Year
GL2000	Chevrolet-Silverado 1500, Silverado 2500 HD, Silverado 3500, Silverado 3500 HD	Tailgate	2019-01
	GMC-Sierra 1500, Sierra 2500 HD, Sierra 3500, Sierra 3500 HD	Tailgate	2019-01
GL2001	Chevrolet-Silverado 1500, Silverado 1500 Classic, Silverado 1500 HD, Silverado 1500 HD Classic, Silverado 2500, Silverado 2500 HD, Silverado 2500 HD Classic, Silverado 3500 Classic	Tailgate	2007-99
	GMC-Sierra 1500, Sierra 1500 Classic, Sierra 1500 HD, Sierra 1500 HD Classic, Sierra 2500, Sierra 2500 HD, Sierra 2500 HD Classic, Sierra 3500 Classic	Tailgate	2007-99
GL2002	Dodge-Ram 1500, Ram 2500, Ram 3500	Tailgate	2009-02
GL2003	Ford-F-150, F-150 Heritage	Tailgate	2014-04
	Lincoln-Mark LT	Tailgate	2008-06
GL2004	Ford-F-150, F-250 Super Duty, F-350 Super Duty	Tailgate	2007-97
GL2005	Ford-F-250 Super Duty, F-350 Super Duty	Tailgate	2016-08
GL2006	Nissan-Frontier	Tailgate	2015-05
GL2007	Toyota-Tacoma	Tailgate	2015-05
GL2008	Ford-F-150	Tailgate	2021-15
GL2009	Ford-F-250 Super Duty, F-350 Super Duty, F-450 Super Duty	Tailgate	2021-17
F4000	Buick-Skylark	Trunk Lid	1983-80
	Oldsmobile-Omega	Trunk Lid	1984-80
	Pontiac-Phoenix	Trunk Lid	1984-80
F4002	Buick-Century, Electra, LeSabre, Regal	Trunk Lid	1985-79
	Chevrolet-Caprice, Impala, Malibu	Trunk Lid	1983-79
	Oldsmobile-98, Cutlass, Cutlass Salon, Delta 88	Trunk Lid	1985-79
	Pontiac-Bonneville, Catalina, Parisienne	Trunk Lid	1983-79
F4003	Chevrolet-Corvette	Hood	1988-84
F4004	Buick-Skylark	Trunk Lid	1983-81
	Oldsmobile-Omega	Trunk Lid	1984-80
	Pontiac-Phoenix	Trunk Lid	1984-81
F4006	Porsche-911, 912, 930	Hood	1988-65
F4023	BMW-735i, 735iL, 740i, 740iL, 750iL	Hood	1994-88
F4024	BMW-525i, 525iT, 530i, 535i, 540i, M5	Hood	1995-89
F4025	BMW-735i, 735iL, 740i, 740iL, 750iL	Trunk Lid	1994-87
F4026	Ford-Explorer	Hood	2001-95
	Mercury-Mountaineer	Hood	2001-97
F4027	Chrysler-Sebring	Trunk Lid	1997-96
E4028	INFINITI-G20	Trunk Lid	1994-91
F4030	BMW-Z3	Deck Lid	2002-96
F4031	Chrysler-Sebring	Trunk Lid	2000-98
F4032	Chrysler-Prowler	Hood	2002-01
	Plymouth-Prowler	Hood	2001-99
F4033	Porsche-968	Hood	1995-92
F4034	Porsche-911, 912, 930	Hood	1988-65

Part No.	Make/Model	Loc	Year
F4035	Volkswagen-Jetta	Hatch	1997-96
E4045	Chrysler-Sebring	Trunk Lid	2006-01
	Dodge-Stratus	Trunk Lid	2006-01
E4046	BMW-318i, 323i, 325i, 328i	Deck Lid	1999-92
E4047	Porsche-911	Trunk Lid	1998-89
E4048	Jeep-Grand Cherokee	Hood	2004-99
	Mazda-6	Trunk Lid	2005-03
E4049	Mercedes-Benz-300SL, 500SL, 600SL, SL320, SL500	Deck Lid	2001-90
E4050	Mercedes-Benz-300CE, E320	Trunk Lid	1995-93
F4051	BMW-Z3	Deck Lid	2002-99
F4052	Porsche-911	Hood	1998-89
E4063	Kia-Optima, Optima	Trunk Lid	2006-01
E4064	Chrysler-300, Sebring	Trunk Lid	2020-01
	Dodge-Charger, Stratus	Trunk Lid	2020-01
F4065	Chevrolet-Corvette	Convertible Top Cover	2004-97
E4066	Chevrolet-Corvette	Trunk Lid	2013-97
F4067	Ford-Explorer Sport, Explorer Sport Trac	Hood	2005-01
F4068	Volvo-S60, S80, V70, XC70	Hood	2009-99
E4069	Buick-Allure, LaCrosse	Trunk Lid	2009-05
F4070	Chrysler-Sebring	Deck Lid	2005-01
E4071	Chevrolet-Impala	Trunk Lid	2008-06
E4072	Pontiac-Grand Prix	Trunk Lid	2008-04
E4073	Ford-Thunderbird	Deck Lid	2005-02
E4074	Ford-Five Hundred, Taurus	Trunk Lid	2009-05
	Mercury-Montego, Sable	Trunk Lid	2009-05
E4075	Ford-Fusion, Fusion, GT	Trunk Lid	2007-05
	Mercury-Milan	Trunk Lid	2007-06
F4078	Nissan-Maxima	Trunk Lid	2008-04
D4079	Pontiac-Vibe	Hatch	2008-03
E4082	Pontiac-Grand Prix	Trunk Lid	2003-97
D4094	Toyota-Prius	Hatch	2009-04
E4095	Mitsubishi-Galant	Trunk Lid	2008-04
F4096	Chrysler-Town & Country	Seat Adjustment Strut	2007-05
	Dodge-Grand Caravan	Seat Adjustment Strut	2007-05
C4097	Pontiac-GTO	Hood	2006-04
F4100	Buick-Regal	Trunk Lid	1982-80
	Chevrolet-Malibu, Monte Carlo	Trunk Lid	1982-80
	Oldsmobile-Cutlass, Cutlass Salon	Trunk Lid	1981-79
	Pontiac-Grand LeMans, Grand Prix, LeMans	Trunk Lid	1982-80
F4101	Buick-Riviera	Trunk Lid	1983-79
	Cadillac-Eldorado	Trunk Lid	1983-79
	Oldsmobile-Toronado	Trunk Lid	1983-79
F4102	Cadillac-Commercial Chassis, DeVille, Fleetwood	Trunk Lid	1985-80

GAS CHARGED LIFT SUPPORTS ARE DESIGNED TO BE USED EXCLUSIVELY FOR THE PURPOSE SPECIFIED IN APPLICATION CHARTS. Tech Support 1-888-565-9632

Part No.	Make/Model	Loc	Year
F4103	Buick-Electra, Estate Wagon, LeSabre	Hood	1990-80
F4104	Lincoln-Continental, Mark VI, Town Car	Hood	1986-80
F4105	Lincoln-Continental, Town Car	Trunk Lid	1989-82
F4106	Lincoln-Town Car	Hood	1989-86
E4107	DeLorean-DMC 12	Door	1983-81
E4111	Volkswagen-Jetta	Trunk Lid	1998-93
E4112	Pontiac-Grand Prix	Trunk Lid	1999-97
E4113	Chevrolet-Cavalier	Deck Lid	2000-95
	Pontiac-Sunfire	Deck Lid	2000-95
F4114	Mercedes-Benz-C220, C230, C280, C36 AMG, C43 AMG	Hood	2000-94
E4115	BMW-323Ci, 323i, 325Ci, 325i, 325xi, 328Ci, 328i, 330Ci, 330i, 330xi	Hood	2006-99
E4116	BMW-X5	Hood	2006-00
E4117	Audi-A4, A4 Quattro, S4	Trunk Lid	2002-96
	Volkswagen-Jetta, Passat	Trunk Lid	2005-98
E4119	Chevrolet-Impala, Lumina, Monte Carlo	Trunk Lid	2005-00
E4120	Chevrolet-Impala, Lumina, Monte Carlo	Trunk Lid	2005-00
E4122	Buick-Century, Regal	Trunk Lid	2005-99
E4123	Volvo-S40	Trunk Lid	2004-00
E4124	BMW-323Ci, 323i, 325Ci, 325i, 325xi, 328Ci, 328i, 330Ci, 330i, 330xi, M3	Trunk Lid	2006-99
E4130	Ford-Focus	Trunk Lid	2004-00
E4131	Pontiac-Aztek	Hood	2005-01
E4132	Mitsubishi-Eclipse	Hatch	2004-00
E4133	Mitsubishi-Eclipse	Trunk Lid	2005-01
E4134	Chevrolet-Camaro	Hood	1992-82
	Pontiac-Firebird	Hood	1992-82
E4135	Mitsubishi-Eclipse	Hatch	2004-00
E4137	Mitsubishi-Eclipse	Trunk Lid	2004-01
E4138	Volvo-850, V70	Hatch	2000-94
E4139	Ford-Excursion	Back Glass	2005-00
E4142	Ford-Explorer, Explorer Sport Trac	Hood	2010-02
E4143	Mercury-Mountaineer	Hood	2010-02
E4144	Saab-9-3	Deck Lid	2003-99
E4145	Hyundai-Sonata	Trunk Lid	2005-02
D4146	Acura-RL, TL	Hood	2001-96
C4150	Buick-Allure, LaCrosse	Hood	2007-05
D4152	Pontiac-Grand Prix	Hood	2004
D4153	Ford-F-150	Hood	2008-05
	Lincoln-Mark LT	Hood	2008
D4154	Ford-Thunderbird	Hood	2005-02
E4155	Lincoln-Town Car	Hood	2005-03
D4156L	Toyota-Cressida	Hood	1992-89
D4156R	Toyota-Cressida	Hood	1992-89
D4157	Honda-Accord	Hood	2007-03
E4159	Toyota-Avalon	Hood	2004-00
E4160	Acura-TL	Hood	2003-02

Part No.	Make/Model	Loc	Year
D4161	Nissan-Maxima	Hood	2003-00
E4162	Nissan-Maxima	Hood	2006-04
C4163L	Mitsubishi-Diamante	Hood	2004-02
C4163R	Mitsubishi-Diamante	Hood	2004-02
D4169	Lincoln-LS, Mark LT	Hood	2007-00
B4171	Toyota-Camry	Hood	2006-02
B4172	Lexus-ES300, ES330	Hood	2006-02
D4174L	Toyota-Solara	Hood	2003-99
D4174R	Toyota-Solara	Hood	2003-99
D4175	Hyundai-Santa Fe	Hood	2006-01
C4176	Cadillac-Catera	Hood	2001-99
E4178	Dodge-Viper	Hood	2006-03
C4179	Lexus-RX330, RX350, RX400h	Hood	2009-04
E4182	Nissan-Armada, Pathfinder Armada, Titan	Hood	2015-04
D4183	Lexus-RX300	Hood	2003-99
D4184	Chevrolet-Blazer, C1500 Suburban, Tahoe	Back Glass	1999-94
	GMC-C1500 Suburban, C2500 Suburban, Yukon	Back Glass	1999-94
D4185	Cadillac-Escalade, Escalade ESV, Escalade EXT	Back Glass	2006-00
	Chevrolet-Suburban 1500, Suburban 2500, Tahoe	Back Glass	2006-00
	GMC-Yukon, Yukon XL 1500, Yukon XL 2500	Back Glass	2006-00
D4187	Mazda-Tribute	Back Glass	2006-01
D4188	Toyota-Matrix	Back Glass	2008-03
D4190	Chevrolet-Blazer, Suburban	Back Glass	1994-92
	GMC-Yukon	Back Glass	1994-92
D4191	Ford-Expedition	Back Glass	2006-03
	Lincoln-Navigator	Back Glass	2006-03
D4192	Hyundai-Santa Fe	Back Glass	2006-01
D4193	Mitsubishi-Endeavor	Back Glass	2008-04
D4194	Nissan-350Z	Hatch	2009-03
D4196	Toyota-Celica	Hatch	2005-00
C4201	INFINITI-Q45	Hood	1996-90
C4202	Mercury-Villager	Liftgate	1996-93
	Nissan-Quest	Liftgate	1998-93
C4203	Ford-Windstar	Hatch	1997-95
C4204	Ford-Taurus	Hood	1999-96
	Mercury-Sable	Hood	1999-96
C4205	Ford-Taurus	Tailgate	2005-96
	Mercury-Sable	Tailgate	2005-96
C4211	Toyota-Starlet	Hatch	1984-81
C4212	Mazda-MPV	Liftgate	1998-89
D4213	Mazda-929	Hood	1991-88
D4214	Ford-Taurus	Hood	1991-86
	Mercury-Sable	Hood	1991-86
C4215	Mazda-GLC	Tailgate	1985-85

GAS CHARGED LIFT SUPPORTS ARE DESIGNED TO BE USED EXCLUSIVELY FOR THE PURPOSE SPECIFIED IN APPLICATION CHARTS.

Tech Support 1-888-565-9632

BUYER'S GUIDE / GUÍA DEL COMPRADOR / GUIDE DE L'ACHETEUR



Part No.	Make/Model	Loc	Year
C4216	Yugo-GV	Hatch	1986
D4217L	Lexus-ES300	Hood	1996-92
	Toyota-Camry	Hood	1996-91
D4217R	Lexus-ES300	Hood	1996-92
	Toyota-Camry	Hood	1996-91
C4218	Jeep-Cherokee	Liftgate	1996-95
C4219	Chevrolet-Astro	Back Glass	2000-92
	GMC-Safari	Back Glass	2000-92
C4220	Volvo-740, 745, 760, 780, 940, 960	Tailgate	1997-83
C4221L	Subaru-Legacy, Outback	Tailgate	2004-95
C4221R	Subaru-Legacy, Outback	Tailgate	2004-95
C4222	Honda-Civic	Tailgate	1987-84
C4249	Jeep-TJ, Wrangler	Back Glass	2006-97
C4250	Dodge-Viper	Hatch	2002-96
D4255	Saab-900	Hood	1998-94
C4256	Chrysler-Concorde, LHS	Hood	2001-98
C4257	Chrysler-300M	Hood	2004-99
	Dodge-Intrepid	Hood	2004-98
C4262	Toyota-Corolla	Hatch	1986-76
C4271	Ford-Aerostar	Liftgate	1993-87
C4273	Ford-Aerostar	Liftgate	1987-86
C4278	Porsche-924, 944, 968	Hatch	1995-87
C4282	Mazda-929	Hood	1995-92
C4283L	Honda-Odyssey	Liftgate	1998-95
	Isuzu-Oasis	Liftgate	1999-96
C4283R	Honda-Odyssey	Liftgate	1998-95
	Isuzu-Oasis	Liftgate	1999-96
C4285	Nissan-240SX	Hatch	1993-90
C4286	Toyota-4Runner	Hatch	2002-96
C4287	Chevrolet-Blazer	Hatch	2003-97
	GMC-Jimmy	Hatch	2001-97
	Oldsmobile-Bravada	Hatch	2001-97
B4288	Saturn-SW1, SW2	Hatch	2001-96
C4289	Cadillac-DeVille	Hood	1999-97
C4290	Dodge-Durango	Liftgate	2003-98
C4291	Jeep-Cherokee	Liftgate	2001-97
C4292	Hyundai-Accent	Hatch	1999-95
D4293	Volkswagen-Golf	Hatch	1998-94
C4294	Honda-CR-V	Back Glass	2001-97
C4295	Buick-Century, Regal	Hood	2005-97
	Chevrolet-Impala	Hood	2005-00
	Oldsmobile-Intrigue	Hood	2002-98
	Pontiac-Grand Prix	Hood	2003-97
B4303L	Hyundai-Excel	Hatch	1994-90
	Mitsubishi-Precis	Hatch	1994-90
B4303R	Hyundai-Excel	Hatch	1994-93
	Mitsubishi-Precis	Hatch	1994-93

Part No.	Make/Model	Loc	Year
B4304	Buick-Terraza	Liftgate	2007-05
	Chevrolet-Uplander, Venture	Liftgate	2009-97
	Oldsmobile-Silhouette	Liftgate	2004-97
	Pontiac-Montana, Trans Sport	Liftgate	2006-97
	Saturn-Relay	Liftgate	2007-05
C4305L	Toyota-Corolla	Tailgate	1996-93
C4305R	Toyota-Corolla	Tailgate	1996-93
C4306	Acura-Legend	Hood	1995-91
C4308	Audi-Quattro	Hatch	1986-83
C4309	Mazda-RX-7	Hatch	1995-93
C4313	Nissan-240Z	Hatch	1973-70
D4316	Chevrolet-Blazer	Back Glass	2005-95
	GMC-Jimmy	Back Glass	2001-95
	Oldsmobile-Bravada	Back Glass	2001-96
C4319L	Ford-Aspire	Hatch	1997-94
C4319R	Ford-Aspire	Hatch	1997-94
D4320	INFINITI-QX4	Back Glass	1999-97
	Nissan-Pathfinder	Back Glass	1999-96
C4321	INFINITI-QX4	Hatch	2000-97
	Nissan-Pathfinder	Hatch	2004-96
C4322L	Ford-Escort	Deck Lid	2003-98
C4322R	Ford-Escort	Deck Lid	2003-98
D4323	Lincoln-Mark VIII	Hood	1998-97
D4324L	Hyundai-Elantra	Tailgate	2000-96
D4324R	Hyundai-Elantra	Tailgate	2000-96
C4325	Volkswagen-Beetle	Hatch	2010-98
E4326	Toyota-Camry	Hood	2001-97
C4327	Toyota-Supra	Hatch	1992-86
B4328	Volkswagen-Beetle	Hood	2010-98
D4329	Volkswagen-Golf, Jetta, Passat	Hatch	2006-98
E4330	Porsche-944, 968	Deck Lid	1995-89
D4331	Mercury-Cougar	Hatch	2002-99
D4332	Oldsmobile-Alero	Hood	2001-99
D4333	Volvo-S70	Trunk Lid	2000-98
D4334	Volvo-S70	Trunk Lid	2000-98
E4335	Volvo-740, 760	Trunk Lid	1992-85
C4336	Oldsmobile-Aurora	Hood	2003-01
	Pontiac-Bonneville	Hood	2005-00
C4337	Cadillac-Catera	Hood	1998-97
D4338	BMW-633CSi, 635CSi, M6	Hood	1989-78
D4339	Ford-Excursion, F-250 Super Duty, F-350 Super Duty, F-450 Super Duty, F-550 Super Duty	Hood	2007-99
D4340	Lincoln-Continental	Hood	1997-95
D4341	Lincoln-Blackwood, Navigator	Hood	2003-98
C4342	Chevrolet-Monte Carlo	Hood	2005-00
C4344	Buick-Park Avenue	Hood	2005-97
D4346	Volkswagen-Cabrio, Golf, Jetta	Hood	2005-99

GAS CHARGED LIFT SUPPORTS ARE DESIGNED TO BE USED EXCLUSIVELY FOR THE PURPOSE SPECIFIED IN APPLICATION CHARTS. Tech Support 1-888-565-9632

Part No.	Make/Model	Loc	Year
D4347	BMW-318i, 325e, 325i, 325is, 325iX, M3	Trunk Lid	1993-84
D4350	Cadillac-Catera	Trunk Lid	2001-97
C4351	Volkswagen-Beetle	Hatch	2010-99
D4352	Honda-Accord	Hood	2002-98
D4353	Pontiac-Aztek	Back Glass	2005-01
D4354	Lincoln-Continental	Hood	2002-98
D4356	Mercury-Villager	Back Glass	2002-99
	Nissan-Quest	Back Glass	2002-99
D4357	Ford-Focus	Hatch	2002-00
D4358	Ford-Focus	Tailgate	2007-00
D4358	Mazda-6	Tailgate	2007-04
E4359	Buick-Rendezvous	Hood	2007-02
D4360	Mini-Cooper	Hatch	2008-02
D4361	Lexus-LX470	Hood	2007-98
	Toyota-Land Cruiser	Hood	2007-98
D4362L	Lexus-LX470, LX570	Hatch	2009-98
	Toyota-Land Cruiser	Hatch	2007-98
D4362R	Lexus-LX470	Hatch	2007-98
	Toyota-Land Cruiser	Hatch	2007-98
D4363	Saturn-Vue	Liftgate	2007-02
D4364	Dodge-Ram 1500, Ram 2500, Ram 3500, Ram 4500, Ram 5500	Hood	2010-02
D4365	Jeep-Liberty	Back Glass	2007-02
D4366	Jeep-Liberty	Hood	2007-02
C4367	Mitsubishi-Diamante	Hatch	1995-93
C4368	Ford-Taurus	Hood	2006-00
	Mercury-Sable	Hood	2005-00
C4369	Ford-Escape	Back Glass	2007-01
	Mercury-Mariner	Back Glass	2007-05
C4370	Ford-Escape	Hatch	2012-01
	Mazda-Tribute	Hatch	2011-08
	Mercury-Mariner	Hatch	2011-05
D4372	Ford-Explorer	Back Glass	2003-02
	Mercury-Mountaineer	Back Glass	2003-02
C4373	Honda-Pilot	Hatch	2007-03
C4375	Nissan-Xterra	Hatch	2004-01
C4379	Toyota-Sequoia, Tundra	Hood	2007-00
C4380	Saab-9-3	Hood	2000-99
D4381	Lexus-GS300	Hood	1997-93
D4382L	Lexus-GS300	Trunk Lid	1997-93
D4382R	Lexus-GS300	Trunk Lid	1997-93
D4383	Hyundai-Sonata	Hood	2005-02
D4385	Jaguar-Vanden Plas, XJ12, XJ6, XJ8, XJR	Hood	2003-95
D4387	Jaguar-Vanden Plas, XJ12, XJ6	Hood	1994-88
C4396	Chrysler-Aspen	Liftgate	2009-07
	Dodge-Durango	Liftgate	2009-06
D4398	Cadillac-SRX	Hood	2009-04

Part No.	Make/Model	Loc	Year
D4400	Dodge-Charger, Omni	Hatch	1987-78
	Plymouth-Horizon, Turismo	Hatch	1987-80
D4401	American Motors-AMX, Eagle, Pacer	Hatch	1983-77
	Ford-Mustang II	Hatch	1978-77
	Plymouth-Horizon	Hatch	1979
D4402	American Motors-Pacer	Hatch	1980-75
D4403	American Motors-Concord, Eagle	Hatch	1988-78
	Ford-Mustang II	Hatch	1978-77
D4404	Buick-Century, Regal	Back Glass	1983-78
	Chevrolet-Malibu, S10 Blazer	Back Glass	1994-78
	GMC-Jimmy, S15 Jimmy	Back Glass	1994-83
	Oldsmobile-Custom Cruiser	Back Glass	1983-78
	Pontiac-Bonneville, Grand LeMans, Grand Safari, LeMans	Back Glass	1983-78
D4405	Ford-Fairmont, LTD, Pinto	Back Glass	1982-74
	Mercury-Bobcat, Marquis, Zephyr	Back Glass	1983-75
	Volkswagen-Golf	Back Glass	1995-85
D4408	American Motors-Hornet	Tailgate	1977
	Ford-Fairmont, Granada, LTD	Tailgate	1986-78
	Ford-Mustang	Hatch	1993-79
	Mercury-Capri	Hatch	1986-79
	Mercury-Cougar, Marquis, Zephyr	Tailgate	1986-78
D4409	Chrysler-LeBaron	Tailgate	1981-78
	Dodge-Aspen, Diplomat	Tailgate	1981-78
	Plymouth-Volare	Tailgate	1980-76
D4411	Buick-Skyhawk	Hatch	1980-75
	Chevrolet-Chevette, Citation, Citation II, Monza	Hatch	1987-75
	Oldsmobile-Starfire	Hatch	1980-75
	Pontiac-Phoenix, Sunbird, T1000	Hatch	1987-77
D4415	Ford-EXP	Hatch	1985-82
	Mercury-LN7	Hatch	1983-82
E4417	Buick-Riviera	Hood	1985-79
	Cadillac-Eldorado, Seville	Hood	1985-79
	Oldsmobile-Toronado	Hood	1985-79
E4421	Buick-Skylark	Hood	1985-80
E4422	Chevrolet-Camaro	Hood	1992-82
	Pontiac-Firebird	Hood	1992-82
D4423	Ford-Bronco II	Back Glass	1990-84
F4426	Cadillac-Seville	Trunk Lid	1985-80
E4428	Buick-Century, Estate Wagon, Regal, Skyhawk	Hood	1996-81
D4429	Nissan-210	Hatch	1982-79
D4430	American Motors-Gremlin, Spirit	Hatch	1983-78
D4431	Toyota-Tercel	Back Glass	1982-80
D4432	Honda-Accord	Hatch	1981-76
D4433	Volvo-145, 245, 265	Tailgate	1978-70
D4434	Subaru-DL, GL, Standard	Hatch	1984-80

GAS CHARGED LIFT SUPPORTS ARE DESIGNED TO BE USED EXCLUSIVELY FOR THE PURPOSE SPECIFIED IN APPLICATION CHARTS.

Tech Support 1-888-565-9632

BUYER'S GUIDE / GUÍA DEL COMPRADOR / GUIDE DE L'ACHETEUR



Part No.	Make/Model	Loc	Year
	Volkswagen-Scirocco	Hatch	1981-75
D4435	Honda-Civic	Hatch	1979-73
D4436	Chrysler-LeBaron	Hatch	1989-85
	Dodge-Lancer	Hatch	1989-85
D4437	Honda-Accord	Hatch	1983-82
D4439	Ford-Taurus	Hood	1995-86
	Mercury-Sable	Hood	1995-86
D4440	Ford-Taurus	Back Glass	1995-86
	Mercury-Sable	Back Glass	1995-86
E4441	Dodge-Ramcharger	Hatch	1980-74
	Plymouth-Trailduster	Hatch	1980-74
D4442	Chrysler-LeBaron, New Yorker, Newport, Town & Country	Hatch	1988-79
	Dodge-Aries, St. Regis	Hatch	1988-79
	Plymouth-Reliant	Hatch	1989-81
	Volkswagen-Rabbit	Hatch	1984-75
D4443	Merkur-XR4Ti	Hatch	1989-85
E4444	Buick-Electra	Hood	1990-85
	Cadillac-Brougham, Commercial Chassis, DeVille, Fleetwood	Hood	1990-85
	Oldsmobile-98, Delta 88	Hood	1991-85
	Pontiac-Bonneville	Hood	1991-87
C4445	Buick-Skyhawk	Hatch	1980-79
	Chevrolet-Monza	Hatch	1980-77
	Pontiac-Sunbird	Hatch	1980-77
E4446	Buick-Skylark, Somerset, Somerset Regal	Hood	1991-85
D4447	Buick-Century	Back Glass	1996-84
	Chevrolet-Celebrity	Back Glass	1990-84
	Oldsmobile-Cutlass Ciera, Cutlass Cruiser	Back Glass	1996-86
	Pontiac-6000	Back Glass	1991-84
D4449	Dodge-Shadow	Hatch	1994-87
	Plymouth-Sundance	Hatch	1994-87
D4450	Volkswagen-Golf	Back Glass	1995-85
D4451	Chevrolet-S10 Blazer	Back Glass	1994-83
	GMC-Jimmy, S15 Jimmy	Back Glass	1994-83
	Oldsmobile-Bravada	Back Glass	1994-91
C4452	Chevrolet-Spectrum	Hatch	1988-85
	Isuzu-I-Mark	Hatch	1989-85
	Pontiac-Sunburst	Hatch	1988-85
E4453	Lincoln-Town Car	Trunk Lid	1982-81
E4454	Porsche-911, 912, 930	Trunk Lid	1988-68
D4455	Renault-Alliance, Encore	Hatch	1987-83
E4456	Chrysler-LeBaron	Deck Lid	1986-84
	Dodge-600	Deck Lid	1986-84
D4457	Chrysler-LeBaron	Deck Lid	1995-87
D4458	Volvo-245, 265	Tailgate	1989-79
D4459	Nissan-Pulsar NX	Hatch	1990-87
D4460	Saab-99, 900	Hatch	1993-69

Part No.	Make/Model	Loc	Year
E4461	Volvo-740, 745, 760, 780, V90	Trunk Lid	1998-83
D4462	Ford-Thunderbird	Hood	1997-89
	Mercury-Cougar	Hood	1997-89
C4463	Buick-Regal	Hood	1996-93
	Chevrolet-Lumina	Hood	1994-93
	Oldsmobile-Cutlass Supreme	Hood	1997-93
	Pontiac-Grand Prix	Hood	1996-93
D4465	Jaguar-XJS	Hood	1992-76
E4466	Lincoln-Town Car	Hood	1997-90
E4467	Ford-Crown Victoria	Hood	1997-92
	Lincoln-Town Car	Hood	2002-98
	Mercury-Grand Marquis	Hood	1997-92
E4468	Chrysler-Concorde, LHS, New Yorker	Hood	1997-93
	Dodge-Intrepid	Hood	1997-93
	Eagle-Vision	Hood	1997-93
E4469	Porsche-924	Hood	1988-77
F4470	BMW-325, 318i, 318is, 325e, 325i, 325is, 325iX	Hood	1991-84
E4471	BMW-318i, 318is, 323i, 323is, 325is, 328i, 328is, M3	Trunk Lid	1999-92
E4472	BMW-525i, 525iT, 530i, 535i, 540i, M5	Trunk Lid	2006-89
F4474	Toyota-Celica	Deck Lid	1985-84
E4475	Ford-Contour	Trunk Lid	2000-95
	Mercury-Mystique	Trunk Lid	2000-95
E4477	Chrysler-Cirrus	Trunk Lid	2000-95
	Dodge-Stratus	Trunk Lid	2000-95
	Plymouth-Breeze	Trunk Lid	2000-96
E4478	Ford-Expedition, F-150, F-150 Heritage, F-250, F-250 HD	Hood	2006-95
E4479	Lincoln-Town Car	Trunk Lid	1983-82
E4484	Volvo-780	Hatch	1991-87
D4490	Dodge-Shadow	Hatch	1994-87
	Plymouth-Sundance	Hatch	1994-87
E4491	Buick-Century, Estate Wagon, Regal	Hood	1987-78
D4496	Buick-Regal	Hood	1992-88
	Chevrolet-Lumina	Hood	1992-90
	Oldsmobile-Cutlass Calais, Cutlass Supreme	Hood	1992-88
	Pontiac-Grand Prix	Hood	1992-88
D4499	Merkur-Scorpio	Hatch	1989-88
E4500	Lexus-SC300, SC400	Trunk Lid	2000-92
E4502	Honda-Civic del Sol	Trunk Lid	1997-93
E4506	Ford-Contour	Trunk Lid	2000-95
	Mercury-Mystique	Trunk Lid	2000-95
D4507	BMW-524td, 528e, 533i, 535i, 535is, M5	Hood	1988-82
E4508	Lexus-SC300, SC400	Trunk Lid	2000-92
D4510	Nissan-NX	Hatch	1993-91
E4519	Buick-Century, LeSabre, Regal	Trunk Lid	1999-97

GAS CHARGED LIFT SUPPORTS ARE DESIGNED TO BE USED EXCLUSIVELY FOR THE PURPOSE SPECIFIED IN APPLICATION CHARTS. Tech Support 1-888-565-9632

Part No.	Make/Model	Loc	Year
E4521	Oldsmobile-Intrigue	Trunk Lid	1999-98
E4522	BMW-Z3	Hood	2002-96
D4523L	Dodge-Stealth	Hood	1996-91
	Mitsubishi-3000GT	Hood	1999-91
D4523R	Dodge-Stealth	Hood	1996-91
	Mitsubishi-3000GT	Hood	1999-91
E4524	INFINITI-I30	Hood	1999-96
	Nissan-Maxima	Hood	1999-95
E4525	Chevrolet-Corvette	Hood	2004-97
	Lincoln-Navigator	Hood	2017-07
D4526	Lexus-LX450	Tailgate	1997-96
	Toyota-Land Cruiser	Tailgate	1991-81
E4527	Chrysler-300M	Trunk Lid	2004-99
E4528	Jeep-Grand Cherokee	Back Glass	2004-99
E4529	Chevrolet-Camaro	Deck Lid	2002-93
	Pontiac-Firebird	Deck Lid	2002-94
F4531	Chevrolet-Blazer	Tailgate	2005-95
	GMC-Jimmy	Tailgate	2001-95
	Oldsmobile-Bravada	Tailgate	2001-96
C4535	Chrysler-Town & Country, Voyager	Liftgate	2007-01
	Dodge-Caravan, Grand Caravan	Liftgate	2007-01
D4536	Lexus-GS300, GS400, GS430	Hood	2005-98
D4537	Mercedes-Benz-E300, E320, E420, E430, E55 AMG	Hood	2003-94
D4538	Ford-Escort	Tailgate	1999-97
	Mercury-Tracer	Tailgate	1999-98
E4539	BMW-525i, 528i, 530i, 540i, M5	Trunk Lid	2003-97
E4540	BMW-740i, 740iL, 750iL	Hood	2001-95
E4541	BMW-525i, 528i, 530i, 540i, M5	Hood	2003-97
C4542	Chevrolet-Camaro	Hood	2002-98
D4543	Pontiac-Firebird	Hood	2002-98
E4544	BMW-840Ci, 850Ci, 850CSi, 850i	Hood	1997-91
D4545	BMW-840Ci, 850Ci, 850CSi, 850i	Trunk Lid	1997-91
D4546	BMW-740i, 740iL, 750iL	Trunk Lid	2001-95
D4547	Lexus-ES300	Hood	2001-97
	Toyota-Camry	Hood	2001-00
D4548L	Mitsubishi-Diamante	Hood	2001-97
D4548R	Mitsubishi-Diamante	Hood	2001-97
D4549L	Toyota-Avalon	Hood	1999-95
D4549R	Toyota-Avalon	Hood	1999-95
E4550	Ford-Crown Victoria	Hood	2011-98
	Mercury-Grand Marquis, Marauder	Hood	2011-98
D4551L	Lexus-LX450	Hood	1997-96
	Toyota-Land Cruiser	Hood	1997-90
D4551R	Lexus-LX450	Hood	1997-96
	Toyota-Land Cruiser	Hood	1997-90
E4553	Chevrolet-Monte Carlo	Trunk Lid	1987

Part No.	Make/Model	Loc	Year
D4554	Mitsubishi-Montero, Montero Sport	Hatch	2004-97
C4555	Mercury-Villager	Liftgate	2002-99
	Nissan-Quest	Liftgate	2002-99
C4556	Mercury-Villager	Liftgate	2002-99
	Nissan-Quest	Liftgate	2002-99
C4557	Cadillac-Escalade	Liftgate	2000-99
	Chevrolet-Suburban 1500, Suburban 2500, Tahoe	Liftgate	2006-95
	GMC-Yukon, Yukon XL 1500, Yukon XL 2500	Liftgate	2004-94
B4558	Honda-Odyssey	Hatch	2002-99
C4559	Ford-Windstar	Liftgate	2003-99
D4560	Chevrolet-Tracker	Door	2004-98
	Suzuki-Grand Vitara, XL-7	Door	2006-99
C4561	Acura-MDX	Hatch	2006-01
C4563	Cadillac-Seville	Hood	1997-96
C4564	Chrysler-PT Cruiser	Tailgate	2008-01
D4566	Lexus-LS400	Hood	1997-95
D4569L	Mitsubishi-Diamante	Hood	1996-92
D4569R	Mitsubishi-Diamante	Hood	1996-92
C4572	Lexus-LS400	Hood	1994-90
C4573	Buick-Rainier	Hatch	2007-04
	Chevrolet-Trailblazer	Hatch	2009-02
	GMC-Envoy	Hatch	2009-02
	Isuzu-Ascender	Hatch	2008-04
	Oldsmobile-Bravada	Hatch	2004-02
	Saab-9-7x	Hatch	2009-05
C4574	Chevrolet-Trailblazer EXT	Liftgate	2006-02
	GMC-Envoy XL, Envoy XUV	Liftgate	2006-02
	Isuzu-Ascender	Liftgate	2006-03
D4575	Chevrolet-Trailblazer EXT	Back Glass	2006-02
	GMC-Envoy XL, Envoy XUV	Back Glass	2006-02
	Isuzu-Ascender	Back Glass	2006-03
	Saturn-Relay	Back Glass	2007-05
C4576	Buick-Rainier	Back Glass	2007-04
	Chevrolet-Trailblazer	Back Glass	2009-02
	GMC-Envoy	Back Glass	2009-02
	Isuzu-Ascender	Back Glass	2008
	Oldsmobile-Bravada	Back Glass	2004-02
E4578	Saab-9-7x	Back Glass	2009-05
	Ford-Expedition, F-150, F-250	Hood	2006-97
C4582	Chevrolet-Impala, Impala Limited, Monte Carlo	Hood	2016-06
C4584	Ford-Explorer	Liftgate	2005-02
	Lincoln-Aviator	Liftgate	2005-03
	Mercury-Mountaineer	Liftgate	2010-02
C4585	Honda-Element	Hatch	2011-03
C4586	Saab-9-3	Hatch	2002-99

GAS CHARGED LIFT SUPPORTS ARE DESIGNED TO BE USED EXCLUSIVELY FOR THE PURPOSE SPECIFIED IN APPLICATION CHARTS.

Tech Support 1-888-565-9632

BUYER'S GUIDE / GUÍA DEL COMPRADOR / GUIDE DE L'ACHETEUR



Part No.	Make/Model	Loc	Year
C4587	Hyundai-Tiburon	Hatch	2008-03
B4588	Kia-Sedona	Liftgate	2005-02
C4589	Nissan-Quest	Liftgate	2013-04
C4590	Toyota-Sienna	Liftgate	2010-05
D4592	Mitsubishi-Endeavor	Liftgate	2008-04
C4593	Ford-Freestar	Liftgate	2007-04
	Mercury-Monterey	Liftgate	2007-04
D4594L	Kia-Sportage	Liftgate	2002-95
D4594R	Kia-Sportage	Liftgate	2002-95
C4596	Mazda-Tribute	Hatch	2006-01
D4597	Scion-tC	Hatch	2010-05
D4598	Toyota-Highlander	Liftgate	2007-01
D4600	Ford-Bronco II	Hatch	1990-84
D4601	Ford-Taurus	Tailgate	1995-86
	Mercury-Sable	Tailgate	1995-86
D4602	Ford-Mustang II	Hatch	1976-74
E4603	Nissan-300ZX	Hood	1989-84
E4604	Toyota-Celica	Hood	1986-82
D4605	Toyota-Cressida	Hood	1988-84
D4606	Toyota-Cressida	Hood	1988-84
F4607	Lincoln-Continental	Trunk Lid	1982
D4608	Ford-Explorer, Explorer Sport	Back Glass	2002-91
	Mazda-Navajo	Back Glass	1994-91
	Mercury-Mountaineer	Back Glass	2001-97
D4609	Volkswagen-Cabriolet, Rabbit	Trunk Lid	1993-82
D4610	Ford-EXP	Hatch	1988-86
C4611	Honda-CRX	Hatch	1991-88
D4612	Volkswagen-Scirocco	Hatch	1989-82
D4613	Dodge-Monaco	Hood	1992-90
	Eagle-Premier	Hood	1992-88
D4614	Buick-Reatta	Trunk Lid	1991-88
D4615	Lincoln-Continental	Hood	1994-88
E4616	Lincoln-Mark VI	Trunk Lid	1983-82
D4617	Cadillac-Allante	Deck Lid	1993-90
D4618	Dodge-Charger, Omni	Hatch	1987-80
	Plymouth-Horizon, Turismo	Hatch	1990-79
D4619	Toyota-Celica	Trunk Lid	1993-86
D4620	Geo-Storm	Hatch	1992-90
	Isuzu-Impulse	Hatch	1992-90
D4621	Audi-100, 200, 5000, 100 Quattro, 200 Quattro, 5000 Quattro, V8 Quattro	Hood	1994-86
D4622	Geo-Storm	Hatch	1993
D4623	Geo-Storm	Hatch	1992-90
E4625	Mercury-Capri	Deck Lid	1994-91
E4626	Mercury-Capri	Deck Lid	1994-91
D4627	Buick-Park Avenue	Hood	1996-93

Part No.	Make/Model	Loc	Year
	Cadillac-60 Special, Brougham, Commercial Chassis, DeVille, Fleetwood	Hood	1993-91
	Oldsmobile-88, 98, LSS, Regency	Hood	1999-91
	Pontiac-Bonneville	Hood	1999-92
D4628	BMW-733i, 735i, L7	Hood	1987-78
D4629	Buick-Skylark	Hood	1998-92
	Oldsmobile-Achieva, Cutlass	Hood	1999-92
C4630	Cadillac-Eldorado, Seville	Hood	2002-92
D4631	Porsche-944	Hood	1991-83
E4632	Chevrolet-Camaro	Deck Lid	1992-87
	Pontiac-Firebird	Deck Lid	1992-89
D4633	Volkswagen-Vanagon	Hatch	1983-80
D4634	Volkswagen-Vanagon	Liftgate	1991-84
D4635	Cadillac-Commercial Chassis, Fleetwood	Hood	1996-93
D4636	Pontiac-Firebird	Hood	1997-93
E4637	BMW-318i, 318ti, 325i, 328i	Hood	1999-92
D4638	Mazda-MX-6	Hatch	1997-93
D4639	Mazda-MX-6	Hatch	1997-93
D4640	Chevrolet-Lumina, Monte Carlo	Hood	2001-95
D4642	Chevrolet-Blazer	Back Glass	2005-95
	GMC-Jimmy	Back Glass	2001-95
D4643	Ford-Mustang	Trunk Lid	2004-94
D4644	Honda-Passport	Back Glass	2002-94
	Isuzu-Amigo, Rodeo, Rodeo Sport	Back Glass	2004-91
D4645	Mercury-Villager	Back Glass	1998-93
	Nissan-Quest	Back Glass	1998-93
D4646	Ford-Taurus	Back Glass	2005-96
	Mercury-Sable	Back Glass	2005-96
D4647	Land Rover-Range Rover	Tailgate	1995-90
D4648	Honda-Civic	Hatch	1995-92
D4649	Ford-Escort	Tailgate	1996-93
	Mercury-Tracer	Tailgate	1996-93
D4650	Cadillac-Escalade	Back Glass	1999
	Chevrolet-C1500 Suburban, C2500 Suburban, K1500 Suburban, K2500 Suburban	Back Glass	1999-92
	GMC-C1500 Suburban, C2500 Suburban, Yukon	Back Glass	1999-94
D4651	Porsche-928	Hood	1995-78
D4652	Porsche-928	Hatch	1995-78
D4654	Toyota-Celica	Trunk Lid	1993-90
D4656	Acura-CL	Hood	1999-97
	Honda-Accord	Hood	1997-95
D4667	Mitsubishi-Eclipse	Deck Lid	1999-97
D4668	Volvo-940, 960, S90	Trunk Lid	1998-91
D4669	Volvo-850	Trunk Lid	1997-93
D4670	Saab-99, 900	Hatch	1993-69

GAS CHARGED LIFT SUPPORTS ARE DESIGNED TO BE USED EXCLUSIVELY FOR THE PURPOSE SPECIFIED IN APPLICATION CHARTS. Tech Support 1-888-565-9632

Part No.	Make/Model	Loc	Year
D4676	Ford-Expedition	Back Glass	2002-97
	Lincoln-Navigator	Back Glass	2002-98
D4678	Jeep-Grand Cherokee	Back Glass	1998-94
E4679	Honda-Accord, Civic	Trunk Lid	1996-92
C4680	Toyota-Celica	Trunk Lid	1999-95
D4681	Ford-Escort	Tailgate	1992-91
	Mercury-Tracer	Tailgate	1992-91
D4686	Dodge-Aspen	Hatch	1977-76
	Ford-Mustang	Hatch	1993-79
	Mercury-Capri, Grand Marquis	Hatch	1986-79
D4687	Buick-LeSabre	Hood	1999-92
D4688	Dodge-Charger, Omni	Hatch	1987-80
	Plymouth-Horizon, TC3, Turismo	Hatch	1987-80
D4689	Mercury-Grand Marquis	Back Glass	1986-84
D4692	INFINITI-J30	Hood	1997-93
D4699	Jeep-Grand Cherokee	Liftgate	2004-99
C4701	Buick-Apollo	Trunk Lid	1975
	Buick-Century, Skylark	Hatch	1979-75
	Chevrolet-Nova	Hatch	1979-75
	Oldsmobile-Omega	Hatch	1979-75
	Pontiac-Phoenix, Ventura	Hatch	1979-75
C4702	Toyota-Celica, Corolla	Hatch	1986-76
C4703	Nissan-200SX	Hatch	1983-80
	Toyota-Celica, Corolla	Hatch	1985-76
C4708	Buick-Skyhawk	Tailgate	1989-83
	Chevrolet-Cavalier	Tailgate	1994-82
	Oldsmobile-Firenza	Tailgate	1988-83
	Pontiac-J2000	Tailgate	1983-82
C4709	Mazda-RX-7	Hatch	1985-79
B4711	Mazda-GLC	Hatch	1985-81
C4712	Chrysler-Laser	Hatch	1986-84
	Dodge-Daytona	Hatch	1993-84
C4713	Dodge-Colt	Hatch	1983-79
	Plymouth-Arrow, Champ	Hatch	1982-79
C4714	Honda-Accord	Hatch	1985-84
C4715	Dodge-Ramcharger	Hatch	1990-81
C4716	Ford-Fiesta	Hatch	1980-78
C4717	Chevrolet-Monza, Vega	Tailgate	1979-74
	Pontiac-Astre	Tailgate	1977-76
B4719	International-Scout	Hatch	1971
C4720	Ford-Granada, LTD	Back Glass	1986-82
	Mercury-Cougar, Marquis	Back Glass	1986-82
C4721	Mercury-Tracer	Hatch	1989-88
C4722	Ford-Escort	Hatch	1990-81
	Mercury-Lynx	Hatch	1987-81
C4724	Chevrolet-Sprint	Hatch	1989-85
	Pontiac-Firefly	Hatch	1988-85

Part No.	Make/Model	Loc	Year
	Suzuki-Forsa	Hatch	1988-87
C4725	Hyundai-Excel	Hatch	1989-86
	Mitsubishi-Precis	Hatch	1989-87
C4726	Chevrolet-Nova	Hatch	1988-86
C4727	Nissan-300ZX	Hatch	1989-84
C4728	Nissan-510	Hatch	1981-78
C4729	Nissan-B210	Hatch	1978-74
C4730	Nissan-310	Hatch	1982-80
C4731	Eagle-Talon	Hatch	1994-90
	Mitsubishi-Eclipse	Hatch	1994-90
	Plymouth-Laser	Hatch	1994-90
C4732	Ford-Escort	Hatch	1990-81
	Mercury-Lynx	Hatch	1987-81
B4733	Dodge-Colt	Hatch	1991-84
	Plymouth-Colt	Hatch	1991-85
B4735	Mazda-626	Hatch	1985-83
B4736	Honda-Civic	Hatch	1983-82
B4737	Dodge-Colt	Hatch	1988-85
B4738	Honda-Civic	Hatch	1981
B4740	Honda-Civic	Hatch	1980
B4741	Mazda-626	Hatch	1985-83
B4742	Dodge-Colt	Hatch	1988-85
B4743	Audi-5000	Hood	1986-84
B4744	Buick-Riviera	Hood	1993-86
	Cadillac-Eldorado, Seville	Hood	1991-86
	Oldsmobile-Toronado	Hood	1992-86
C4746	Nissan-Stanza	Hatch	1984-82
C4747	Nissan-Stanza	Hatch	1984-82
C4750	Pontiac-LeMans	Hatch	1993-88
C4751	Nissan-Stanza	Hatch	1987-82
D4752	Isuzu-Impulse	Hood	1987-83
B4753	Toyota-Camry	Hatch	1984-83
C4754	Ford-Explorer, Explorer Sport	Hatch	2003-91
	Mazda-Navajo	Hatch	1994-91
	Mercury-Mountaineer	Hatch	2001-97
C4755	Buick-Commercial Chassis, Roadmaster	Hood	1996-91
	Chevrolet-Caprice, Commercial Chassis, Impala	Hood	1996-91
	Oldsmobile-Custom Cruiser	Hood	1992-91
C4756	Nissan-240SX	Hatch	1990-89
C4757	Honda-Civic	Tailgate	1983-80
C4758	Nissan-Pathfinder	Liftgate	1995-87
C4759	Volkswagen-Quantum	Tailgate	1988-82
C4760	Saab-9000	Hood	1998-86
C4761	Jeep-Wrangler	Back Glass	1995-87
D4762	Buick-Roadmaster	Back Glass	1996-91
	Chevrolet-Caprice, Commercial Chassis	Back Glass	1996-91

GAS CHARGED LIFT SUPPORTS ARE DESIGNED TO BE USED EXCLUSIVELY FOR THE PURPOSE SPECIFIED IN APPLICATION CHARTS.

Tech Support 1-888-565-9632

BUYER'S GUIDE / GUÍA DEL COMPRADOR / GUIDE DE L'ACHETEUR



Part No.	Make/Model	Loc	Year
	Oldsmobile-Custom Cruiser	Back Glass	1992-91
C4763	Toyota-Corolla	Hatch	1988-87
C4764	Saab-9000	Hatch	1986
C4772	Dodge-Ramcharger	Hatch	1993-91
C4775	Chrysler-Town & Country	Hatch	1990-84
	Dodge-Caravan	Hatch	1990-84
	Plymouth-Trailduster, Voyager	Hatch	1990-81
C4776	Buick-Century	Hatch	1996-84
	Chevrolet-Celebrity	Hatch	1990-84
	Oldsmobile-Cutlass Ciera, Cutlass Cruiser	Hatch	1996-84
	Pontiac-6000	Hatch	1991-84
C4777	Nissan-260Z, 280Z	Hatch	1978-74
B4778	Mazda-GLC	Hatch	1980-77
C4779	Toyota-Tercel	Hatch	1986-80
B4780	Subaru-DL, GL	Tailgate	1984-80
C4781	Ford-Aerostar	Liftgate	1997-87
C4782	Jeep-Cherokee, Grand Wagoneer, Wagoneer	Hatch	1994-84
C4784	Ford-Aerostar	Hatch	1987-86
	Peugeot-505	Hatch	1991-84
B4786	Nissan-Maxima	Hood	1988-85
B4787	Chevrolet-Lumina APV	Hatch	1991
	Oldsmobile-Silhouette	Hatch	1991-90
	Pontiac-Trans Sport	Hatch	1991-90
D4788	BMW-325i	Deck Lid	1989-87
C4789	Chevrolet-Tracker	Door	1991-90
	Geo-Tracker	Door	1997-90
	Suzuki-Sidekick	Door	1998-92
C4793	Cadillac-DeVille	Hood	1996-94
C4794	Chevrolet-Camaro	Hood	1997-93
D4796	Dodge-D150, D250, D350, Ramcharger, W150, W250, W350	Seat Adjustment Strut	1993-88
C4799	Chevrolet-Blazer	Back Glass	2003-97
	GMC-Jimmy	Back Glass	2001-97
	Oldsmobile-Bravada	Back Glass	2001-97
B4800	Nissan-280ZX	Hatch	1983-79
	Saab-9-5	Deck Lid	2005-99
B4805	Toyota-Tercel	Tailgate	1988-83
B4806	Nissan-200SX	Hatch	1988-84
B4807	Nissan-280ZX	Hatch	1983-79
A4808	Acura-Integra	Hatch	1989-86
B4809	Mercedes-Benz-190D, 190E	Hood	1993-84
C4810	Honda-Civic	Hatch	1987-84
C4811	Honda-Accord	Hatch	1989-86
C4812	Honda-Civic	Hatch	1991-88
	Nissan-Sentra	Hatch	1986-82
D4813	Acura-Legend	Hood	1990-86
B4814	Nissan-300ZX	Hatch	1996-89

Part No.	Make/Model	Loc	Year
D4815	Nissan-Pathfinder	Back Glass	1995-87
D4816	Nissan-Pathfinder	Back Glass	1995-87
B4817	Honda-Civic	Hatch	1987-84
B4818	Nissan-300ZX	Hatch	1993-89
E4819	Isuzu-Impulse	Hatch	1989-85
E4820	Isuzu-Impulse	Hatch	1989-85
B4821	Cadillac-Allante	Hood	1993-87
B4822	Toyota-Van	Liftgate	1989-84
B4823	Toyota-Van	Liftgate	1989-84
B4824	Nissan-Maxima	Tailgate	1988-85
C4825	Nissan-300ZX	Hatch	1993-84
C4826	Geo-Metro	Hatch	1994-89
	Pontiac-Firefly	Hatch	1994-90
	Suzuki-Swift	Hatch	1994-89
C4827	Geo-Metro	Hatch	1994-89
	Pontiac-Firefly	Hatch	1994-90
	Suzuki-Swift	Hatch	1994-89
B4829	Nissan-300ZX	Hatch	1994-89
B4830	Buick-Reatta	Hood	1991-88
B4831	Ford-Festiva	Hatch	1993-88
C4832	Ford-Probe	Hatch	1992-89
C4833	Ford-Probe	Hatch	1992-89
C4834	Chrysler-Town & Country	Liftgate	1995-91
	Dodge-Caravan, Grand Caravan	Liftgate	1995-91
	Plymouth-Grand Voyager, Voyager	Liftgate	1995-91
C4835	Ford-Probe	Hatch	1992-89
C4836	Ford-Probe	Hatch	1992-89
C4837	Chrysler-Grand Voyager, Town & Country	Liftgate	1995-91
	Dodge-Caravan, Grand Caravan	Liftgate	1995-91
	Plymouth-Grand Voyager, Voyager	Liftgate	1995-91
B4838	Toyota-Cressida	Tailgate	1987-85
B4839	Ford-Escort	Hatch	1997-91
	Mercury-Tracer	Hatch	1999-91
B4840	Ford-Escort	Hatch	1997-91
	Mercury-Tracer	Hatch	1999-91
D4841	Ford-Probe	Hatch	1997-93
D4842	Ford-Probe	Hatch	1997-93
B4849	Chevrolet-Lumina APV	Hatch	1996-92
B4849	Oldsmobile-Silhouette	Hatch	1996-95
A4850	Audi-5000	Hood	1983-78
A4851	Nissan-Sentra	Hatch	1990-87
A4852	Nissan-Sentra	Tailgate	1985-82
C4853	Nissan-210	Tailgate	1982-79
B4855	Oldsmobile-Silhouette	Liftgate	1996-92
	Pontiac-Trans Sport	Liftgate	1996-92
D4856	Jeep-Grand Cherokee	Hatch	1998-93
D4857	Jeep-Grand Cherokee	Hatch	1998-93

GAS CHARGED LIFT SUPPORTS ARE DESIGNED TO BE USED EXCLUSIVELY FOR THE PURPOSE SPECIFIED IN APPLICATION CHARTS. Tech Support 1-888-565-9632

Part No.	Make/Model	Loc	Year
D4858	Ford-Probe	Hatch	1997-93
D4859	Ford-Probe	Hatch	1997-93
B4860	Chevrolet-Camaro	Hatch	2002-93
B4865	Chrysler-Grand Voyager, Town & Country, Voyager	Hatch	2000-96
	Dodge-Caravan, Grand Caravan	Hatch	2000-96
	Plymouth-Grand Voyager, Voyager	Hatch	2000-96
B4866L	Daihatsu-Charade	Hatch	1992-88
B4866R	Daihatsu-Charade	Hatch	1992-88
B4867L	Subaru-Legacy	Tailgate	1994-90
B4867R	Subaru-Legacy	Tailgate	1994-90
C4868L	Honda-Accord	Hatch	1993-91
C4868R	Honda-Accord	Hatch	1993-91
C4869L	Honda-Accord	Tailgate	1997-94
C4869R	Honda-Accord	Tailgate	1997-94
C4870L	Honda-Civic	Hatch	2000-96
C4870R	Honda-Civic	Hatch	2000-96
F4874	Lincoln-Mark VI	Trunk Lid	1981-80
F4875	Lincoln-Continental, Versailles	Trunk Lid	1980
B4876	Saab-9000	Hatch	1993-88
B4877	Saab-9000	Hatch	1993-88
C4879	Saab-900	Hatch	1998-94
	Saturn-L300, LW1, LW2, LW200, LW300	Hatch	2004-00
C4880	Audi-5000	Hatch	1988-87
	Saab-900	Hatch	1998-94
D4881	Lincoln-Mark VIII	Hood	1996-93
E4882	Lincoln-Mark VI	Trunk Lid	1983-81
B4885	Chevrolet-Lumina APV	Hatch	1994-90
B4896	Ford-Escort	Hatch	1999-91
	Mercury-Tracer	Hatch	1999-91
B4897	Pontiac-Firebird	Hatch	2002-93
A4899	Nissan-Sentra	Tailgate	1989-86
A4900	Chevrolet-Camaro	Hatch	1992-82
	Pontiac-Firebird	Hatch	1992-82
A4901	Buick-Skyhawk	Hatch	1987-83
	Chevrolet-Cavalier	Hatch	1987-82
	Oldsmobile-Firenza	Hatch	1988-82
	Pontiac-J2000, J2000 Sunbird, Sunbird	Hatch	1987-82
A4902	American Motors-AMX, Concord, Hornet	Hatch	1980-73
A4903	Chevrolet-Corvette	Hatch	1996-84
A4904	Chevrolet-Corvette	Hatch	1996-84
C4905	Toyota-Celica	Hatch	1987-85
C4906	Toyota-Celica	Hatch	1987-85
C4907	Mazda-323	Hatch	1988-86
C4908	Geo-Prizm	Hatch	1992-89
C4909	Honda-Civic	Hatch	1991-88
C4910	Mazda-323	Hatch	1988-86

Part No.	Make/Model	Loc	Year
C4911	Mazda-323	Hatch	1995-90
C4912	Mazda-323	Hatch	1995-90
D4913	Nissan-Maxima	Hood	1994-89
D4914	Nissan-Maxima	Hood	1994-89
B4915	Nissan-Stanza	Tailgate	1988-86
B4916	Nissan-Stanza	Tailgate	1988-86
B4917	Toyota-Previa	Hatch	1997-91
B4918	Toyota-Previa	Hatch	1997-91
B4919	Geo-Metro	Deck Lid	1993-90
B4929	Toyota-Celica	Hatch	1993-90
B4930	Toyota-Celica	Hatch	1993-90
B4933	Nissan-Pulsar NX	Hatch	1986-83
B4934	Nissan-Pulsar NX	Hatch	1986-83
C4938	Mercury-Tracer	Tailgate	1989-88
C4939	Mercury-Tracer	Tailgate	1989-88
A4941	Nissan-310	Hatch	1982-79
A4942	Nissan-310	Hatch	1982-79
B4949L	Subaru-DL, GL, Loyale	Tailgate	1994-85
B4949R	Subaru-DL, GL, Loyale	Tailgate	1994-85
C4951L	Toyota-Camry	Tailgate	1996-92
C4951R	Toyota-Camry	Tailgate	1996-92
A4952L	Eagle-Talon	Hatch	1998-95
	Mitsubishi-Eclipse	Hatch	1999-95
A4952R	Eagle-Talon	Hatch	1998-95
	Mitsubishi-Eclipse	Hatch	1999-95
A4954	Chevrolet-Camaro	Hatch	1992-82
C4955L	Toyota-Celica	Hatch	1999-94
C4955R	Toyota-Celica	Hatch	1999-94
E4956	Chrysler-Concorde, LHS	Trunk Lid	2004-98
D4957	Oldsmobile-Aurora	Trunk Lid	1999-95
E4958	Dodge-Intrepid	Trunk Lid	2004-98
E4959	Chrysler-Prowler	Deck Lid	2002-01
	Plymouth-Prowler	Deck Lid	2001-97
C4961L	Dodge-Colt	Hatch	1995-89
	Eagle-Summit	Hatch	1994-89
	Mitsubishi-Mirage	Hatch	1993-89
	Plymouth-Colt	Hatch	1995-89
C4961R	Dodge-Colt	Hatch	1995-89
	Eagle-Summit	Hatch	1994-89
	Mitsubishi-Mirage	Hatch	1993-89
	Plymouth-Colt	Hatch	1995-89
B4962	Chevrolet-Corsica	Trunk Lid	1991-89
	Pontiac-Tempest	Trunk Lid	1991-89
C4963L	Toyota-Camry	Tailgate	1991-87
C4963R	Toyota-Camry	Tailgate	1991-87
C4964	Ford-Expedition	Liftgate	2002-97

GAS CHARGED LIFT SUPPORTS ARE DESIGNED TO BE USED EXCLUSIVELY FOR THE PURPOSE SPECIFIED IN APPLICATION CHARTS.

Tech Support 1-888-565-9632

BUYER'S GUIDE / GUÍA DEL COMPRADOR / GUIDE DE L'ACHETEUR



Part No.	Make/Model	Loc	Year
	Lincoln-Navigator	Liftgate	2002-98
A4965	Buick-Riviera	Hood	1999-95
	Cadillac-Seville	Hood	1999-98
	Oldsmobile-Aurora	Hood	1999-95
C4966	Buick-Riviera	Trunk Lid	1999-95
A4967	Chevrolet-Camaro	Hatch	1992-82
	Pontiac-Firebird	Hatch	1992-82
A4968	Acura-Integra	Hatch	1993-90
A4972	Chevrolet-Corvette	Hood	1996-88
A4973	Chevrolet-Corvette	Hatch	1982
A4979	Acura-Integra	Hatch	2001-94
B4980	Mazda-323	Tailgate	1988-87
B4981	Saturn-SW1, SW2	Tailgate	1995-93
A4982	Dodge-Stealth	Hatch	1996-91
	Mitsubishi-3000GT	Hatch	1999-91
B4984	Mazda-MX-3	Hatch	1996-92
A4985	Hyundai-Tiburon	Hatch	1999-97
A4986	Buick-LeSabre	Hood	2005-00
B4987L	Chevrolet-Metro	Hatch	2001-98
	Geo-Metro	Hatch	1997-95
	Suzuki-Swift	Hatch	2001-95
B4987R	Chevrolet-Metro	Hatch	2001-98
	Geo-Metro	Hatch	1997-95
	Suzuki-Swift	Hatch	2001-95
B4988	Volvo-S40, V40	Hood	2004-00
B4989	Audi-A6, A6 Quattro, Allroad Quattro, RS6, S6	Hood	2005-98
	Volkswagen-Passat	Hood	2005-98
B4990	BMW-525i, 530i	Tailgate	1995-93
A4991	Cadillac-Seville	Hood	2004-00
B4992	Buick-Rendezvous	Hatch	2007-02
B4993	Cadillac-DeVille	Hood	2005-00
C4994	Toyota-Sienna	Liftgate	2003-98
B4995	Toyota-Sequoia	Liftgate	2007-01
B4998L	Mazda-929	Trunk Lid	1995-92
B4998R	Mazda-929	Trunk Lid	1995-92
PG5000L	BMW-X5	Power Liftgate	2013-07
PG5000R	BMW-X5	Power Liftgate	2013-07
PG5011L	BMW-X3	Power Liftgate	2017-11
PG5011R	BMW-X3	Power Liftgate	2017-11
PG5012L	BMW-740Li	Power Liftgate	2015-11
PG5012R	BMW-740Li	Power Liftgate	2015-11
PG5013	Land Rover-Range Rover Evoque	Power Liftgate	2017-12
PG5014	Volkswagen-Touareg	Power Liftgate	2017-11
PG5016	Audi-Q3, Q3 Quattro	Power Liftgate	2018-15
PG5017	Porsche-Panamera	Power Liftgate	2016-10
PG5018	Porsche-Cayenne	Power Liftgate	2016-11

Part No.	Make/Model	Loc	Year
PG5019	Land Rover-Range Rover Sport	Power Liftgate	2013-12
PG5020	Land Rover-Range Rover Sport	Power Liftgate	2020-14
PG5021L	Volvo-XC60	Power Liftgate	2017-12
PG5021R	Volvo-XC60	Power Liftgate	2017-12
B6000	Audi-A3, A3 Quattro	Hood	2013-06
B6001	Volkswagen-Golf, Golf R, GTI, Jetta	Hood	2014-10
C6002	Subaru-Forester	Hood	2018-14
C6006L	Mercedes-Benz-GL320, GL350, GL450, GL550	Hood	2012-07
C6006R	Mercedes-Benz-GL320, GL350, GL450, GL550	Hood	2012-07
C6007	Audi-A3, A3 Quattro	Hatch	2013-06
C6008	Honda-Pilot	Liftgate	2008
D6010	BMW-640i, 640i xDrive, 650i, 650i xDrive	Trunk Lid	2014-12
D6011	Scion-xD	Hatch	2014-08
D6013	Ford-Focus	Trunk Lid	2018-12
E6014	Volvo-S60, S60 Cross Country, V60, V60 Cross Country	Hood	2018-11
E6015	Dodge-Viper	Hatch	2010-06
D6016	INFINITI-QX56, QX80	Hood	2018-11
D6017	Volkswagen-Jetta	Trunk Lid	2018-11
E6018	BMW-320i, 320i xDrive, 328d, 328d xDrive, 328i, 328i xDrive, 330e, 335i, 335i xDrive, 340i, 340i xDrive, ActiveHybrid 3, M3	Trunk Lid	2017-12
C6019	Chevrolet-Equinox	Hatch	2017-10
E6020	Hyundai-Sonata	Hood	2017-15
E6021	INFINITI-M35h, M37, M56, Q70, Q70L	Hood	2019-11
E6022	INFINITI-M35h, M37, M56	Trunk Lid	2013-11
E6023	BMW-640i, 640i xDrive, 650i, 650i xDrive, M6	Deck Lid	2018-12
	Mercedes-Benz-SL500	Deck Lid	2014-12
E6024	BMW-528i, 528i xDrive, 535d, 535d xDrive, 535i, 535i xDrive, 550i, 550i GT, 550i GT xDrive, 550i xDrive, 640i, 640i Gran Coupe, 640i xDrive, 640i xDrive Gran Coupe, 650i, 650i Gran Coupe, 650i xDrive, 650i xDrive Gran Coupe, ActiveHybrid 5, Alpina B6 xDrive	Hood	2017-11
F6025	BMW-228i, 228i xDrive, 320i, 328d, 328d xDrive, 328i, 328i GT xDrive, 328i xDrive, 335i, 335i GT xDrive, 335i xDrive, 428i, 428i Gran Coupe, 428i xDrive, 428i xDrive Gran Coupe, 435i, 435i xDrive, 435i xDrive Gran Coupe, M235i, M235i xDrive	Hood	2016-12
F6026	Mercedes-Benz-SLK280, SLK300, SLK350, SLK55 AMG	Deck Lid	2011-05
C6027	Lincoln-MKZ	Hood	2016-13
E6028	BMW-328i, 328i xDrive, 328xi, 335i, 335i xDrive, 335is, M3	Trunk Lid	2013-07
F6030	Mini-Cooper	Hood	2015-07
C6100	Ford-Expedition	Hatch	2017-03
C6101	Chevrolet-Blazer	Liftgate	2001-00

GAS CHARGED LIFT SUPPORTS ARE DESIGNED TO BE USED EXCLUSIVELY FOR THE PURPOSE SPECIFIED IN APPLICATION CHARTS. Tech Support 1-888-565-9632

Part No.	Make/Model	Loc	Year
	GMC-Jimmy	Liftgate	2001-00
	Oldsmobile-Bravada	Liftgate	2001-00
C6102	Lexus-RX300	Liftgate	2003-99
D6103	Dodge-Magnum	Tailgate	2008-05
D6104	Jeep-Grand Cherokee	Hatch	2007-05
C6105	Kia-Sorento	Liftgate	2009-03
C6106	Lincoln-Navigator	Liftgate	2017-03
D6107	Toyota-4Runner	Liftgate	2009-03
C6108	Chevrolet-Equinox	Liftgate	2009-05
	Pontiac-Torrent	Liftgate	2009-06
C6109	Hyundai-Santa Fe	Liftgate	2006-01
D6110	Nissan-Pathfinder	Hatch	2012-05
C6111	Honda-Odyssey	Hatch	2004-03
C6113L	Mazda-MPV	Liftgate	2006-00
C6113R	Mazda-MPV	Liftgate	2006-00
C6114	Mercedes-Benz-ML320, ML350, ML430, ML500, ML55 AMG	Hatch	2007-98
D6115	Mitsubishi-Outlander	Liftgate	2006-03
D6116	Cadillac-SRX	Hatch	2009-04
B6117	Honda-Odyssey	Hatch	2010-05
C6118	Hyundai-Entourage	Liftgate	2008-07
	Kia-Sedona	Liftgate	2012-06
C6119L	Nissan-Xterra	Liftgate	2000
C6119R	Nissan-Xterra	Liftgate	2000
C6120	Ford-Edge	Hatch	2014-07
D6121	Nissan-Murano	Liftgate	2004-03
D6122	Nissan-Murano	Liftgate	2007-05
C6123	Chevrolet-HHR	Hatch	2011-06
C6124	Chrysler-Town & Country	Liftgate	2016-08
	Dodge-Grand Caravan	Liftgate	2017-08
	Ram-C/V	Liftgate	2015-12
D6127	Lexus-RX330	Liftgate	2006-04
D6129	Hyundai-Tucson	Hatch	2009-05
C6132	Volkswagen-EuroVan	Hatch	2003-96
C6133	Volvo-XC90	Hatch	2014-03
C6134	Kia-Rondo	Hatch	2010-07
D6135	Lexus-RX350, RX400h	Hatch	2009-06
C6136	BMW-X3	Hatch	2010-04
D6137	Nissan-Xterra	Hatch	2015-05
D6138	Jeep-Patriot	Hatch	2016-07
C6139	Ford-Explorer	Hatch	2010-06
C6140	Toyota-Sienna	Liftgate	2010-06
E6143	Saab-9-5	Trunk Lid	2009-99
C6144	Saturn-Vue	Hood	2007-06
D6145	Acura-RSX	Hatch	2004-02

Part No.	Make/Model	Loc	Year
D6146L	Toyota-Celica	Hatch	2005-00
D6146R	Toyota-Celica	Hatch	2005-00
C6147	DeLorean-DMC 12	Trunk Lid	1983-81
D6148	DeLorean-DMC 12	Hood	1983-81
E6149	INFINITI-QX56	Hood	2010-04
D6150	Honda-CR-V	Door	2001-97
C6151	Chevrolet-Suburban 1500, Suburban 2500, Tahoe	Hatch	2006-05
	GMC-Yukon, Yukon XL 1500, Yukon XL 2500	Hatch	2006-05
C6152	GMC-Acadia	Liftgate	2016-07
	Saturn-Outlook	Liftgate	2010-07
C6153	GMC-Acadia	Hood	2012-07
C6154	Chrysler-Pacifica	Hatch	2008-04
C6155	Cadillac-Escalade, Escalade ESV, Escalade EXT	Hood	2014-07
	Chevrolet-Avalanche, Suburban, Suburban 1500, Suburban 2500, Tahoe	Hood	2014-07
	GMC-Yukon, Yukon XL 1500, Yukon XL 2500	Hood	2014-07
C6156	Cadillac-Escalade, Escalade ESV, Escalade EXT	Hatch	2014-07
	Chevrolet-Suburban, Suburban 1500, Suburban 2500, Tahoe	Hatch	2014-07
	GMC-Yukon, Yukon XL 1500, Yukon XL 2500	Hatch	2014-07
D6157	Cadillac-Escalade, Escalade ESV, Escalade EXT	Back Glass	2014-07
	Chevrolet-Suburban, Suburban 1500, Suburban 2500, Tahoe	Back Glass	2015-07
	GMC-Yukon, Yukon XL 1500, Yukon XL 2500	Back Glass	2014-07
B6159	Buick-Lucerne	Hood	2011-06
	Cadillac-DTS	Hood	2011-06
B6160	Volkswagen-Passat	Hood	2010-06
D6161	Volkswagen-Passat	Hatch	2010-07
B6162	Volkswagen-Golf, GTI, Jetta, R32, Rabbit	Hood	2009-06
D6163	Volkswagen-Golf, GTI, R32, Rabbit	Hatch	2009-06
C6164	Buick-Enclave	Hood	2017-08
C6165	Buick-Enclave	Hatch	2017-08
D6166	Chevrolet-Malibu	Hood	2012-08
	Saturn-Aura	Hood	2009-08
E6167	Chevrolet-Malibu	Trunk Lid	2012-08
B6168	Cadillac-STS	Hood	2011-05
E6169	Cadillac-STS	Trunk Lid	2011-05
E6170	Chrysler-Sebring	Deck Lid	2009-08
E6171	Saturn-Aura	Trunk Lid	2009-07
D6172	Mitsubishi-Eclipse	Hatch	2012-06
D6173	Suzuki-Grand Vitara	Door	2013-06
C6174	Suzuki-XL-7	Hatch	2009-07

GAS CHARGED LIFT SUPPORTS ARE DESIGNED TO BE USED EXCLUSIVELY FOR THE PURPOSE SPECIFIED IN APPLICATION CHARTS.

Tech Support 1-888-565-9632

BUYER'S GUIDE / GUÍA DEL COMPRADOR / GUIDE DE L'ACHETEUR



Part No.	Make/Model	Loc	Year
D6175	Honda-Accord	Hood	2012-08
E6176	Nissan-Murano	Hood	2014-09
D6177	Nissan-Murano	Liftgate	2014-09
D6178	Dodge-Nitro	Hatch	2012-07
C6179	Honda-CR-V	Liftgate	2011-07
E6180	Mitsubishi-Galant	Trunk Lid	2012-08
C6181	Dodge-Durango	Liftgate	2005-04
B6182	Chevrolet-Camaro	Hood	2015-10
E6183	Chevrolet-Camaro	Trunk Lid	2015-10
D6184	Hyundai-Veracruz	Hood	2012-07
C6185	Hyundai-Veracruz	Hatch	2009-07
C6186	Jeep-Commander	Liftgate	2010-06
C6187	Jeep-Compass, Patriot	Liftgate	2017-07
A6188	Chrysler-Crossfire	Hood	2008-04
D6189	Chrysler-Crossfire	Hatch	2008-04
C6190	Mercedes-Benz-C300, C350, C63 AMG	Hood	2012-08
D6191L	Toyota-Celica	Hatch	2005-00
D6191R	Toyota-Celica	Hatch	2005-00
D6192	INFINITI-QX4	Back Glass	2003-99
	Nissan-Pathfinder	Back Glass	2004-99
E6193	Jeep-Commander	Hood	2010-06
D6194	Jeep-Commander	Back Glass	2010-06
C6195	Kia-Optima	Hood	2010-06
C6196	Ford-F-250 Super Duty, F-350 Super Duty, F-450 Super Duty, F-550 Super Duty	Hood	2016-11
C6197	Jeep-Compass, Patriot	Liftgate	2017-07
C6199	Ford-Freestyle, Taurus X	Tailgate	2009-06
C6202	Kia-Rio	Tailgate	2005-02
C6203L	Mazda-Protege5	Hatch	2003-02
C6203R	Mazda-Protege5	Hatch	2003-02
D6204	Toyota-Matrix	Tailgate	2008-03
C6206L	Scion-xB	Hatch	2006-04
C6206R	Scion-xB	Hatch	2006-04
C6213	Honda-CR-V	Door	2006-02
C6215	Subaru-Impreza	Tailgate	2007-02
D6216	Dodge-Caliber	Hatch	2012-07
D6217	Daewoo-Nubira	Hatch	2002-99
C6219L	Subaru-Forester	Tailgate	2005-03
C6219R	Subaru-Forester	Tailgate	2005-03
B6220L	Subaru-Forester	Tailgate	1999-98
B6220R	Subaru-Forester	Tailgate	1999-98
C6222L	Subaru-Legacy, Outback	Tailgate	2009-05
C6222R	Subaru-Legacy, Outback	Tailgate	2009-05
E6224	Chrysler-200, Sebring	Trunk Lid	2014-07
	Dodge-Avenger	Trunk Lid	2014-08
C6225	Subaru-Impreza	Hatch	2001-98
E6226	Subaru-SVX	Trunk Lid	1997-92

Part No.	Make/Model	Loc	Year
D6228	Lexus-GX470	Hood	2009-03
	Toyota-4Runner	Hood	2009-03
A6229	Mazda-RX-7	Hatch	1991-86
F6231	Mitsubishi-Eclipse	Trunk Lid	2011-07
E6232	Lexus-SC430	Hood	2010-02
C6234	Land Rover-Freelander	Door	2006-02
C6235	Cadillac-Escalade, Escalade ESV, Escalade EXT	Liftgate	2004-02
D6236	Lexus-LS430	Hood	2006-01
C6237	Lexus-IS300	Hatch	2004-02
B6238	Honda-Odyssey	Hatch	2010-05
C6239	Honda-Insight	Hatch	2006-00
B6240	Hyundai-Azera	Hood	2011-06
B6241	Cadillac-XLR	Hood	2009-04
D6242	Chevrolet-Captiva Sport	Hood	2015-12
	Saturn-Vue	Hood	2010-08
C6243	Chevrolet-Captiva Sport	Liftgate	2015-12
	Saturn-Vue	Liftgate	2010-08
D6244	Toyota-Prius, Prius Plug-In	Hatch	2012-10
B6245	BMW-745i, 745Li, 750i, 750Li, 760i, 760Li, Alpina B7	Hood	2010-02
C6246	Ford-Flex	Liftgate	2016-09
D6247	Volkswagen-Vanagon	Liftgate	1991-82
C6248	Hyundai-Tiburon	Hatch	2008-03
C6249	Cadillac-CTS	Hood	2013-08
E6250	Cadillac-CTS	Trunk Lid	2014-08
D6253	Ford-Expedition	Back Glass	2017-07
	Lincoln-Navigator	Back Glass	2017-07
E6254	Chrysler-200, Sebring	Trunk Lid	2013-10
E6255	Chevrolet-Impala, Impala Limited	Trunk Lid	2016-06
D6256	Dodge-Caliber	Hatch	2012-07
C6257	Chrysler-Town & Country	Liftgate	2016-08
	Dodge-Grand Caravan	Liftgate	2019-08
	Ram-C/V	Liftgate	2015-12
D6258	BMW-Z4	Hood	2008-03
E6259	BMW-Z4	Deck Lid	2009-03
D6260	Ford-Escape	Back Glass	2012-08
	Mazda-Tribute	Back Glass	2011-08
	Mercury-Mariner	Back Glass	2011-08
D6261	Kia-Sorento	Liftgate	2013-11
C6262	Cadillac-Escalade, Escalade ESV	Hatch	2006-05
D6264	Toyota-Highlander	Back Glass	2013-08
D6265	Volkswagen-Passat	Hatch	1995-90
D6266	Peugeot-505	Trunk Lid	1991-89
D6267	Kia-Sorento	Hood	2015-11
B6268	Pontiac-Firebird	Hatch	2002-93
D6269	Nissan-Rogue, Rogue Select	Liftgate	2015-08

GAS CHARGED LIFT SUPPORTS ARE DESIGNED TO BE USED EXCLUSIVELY FOR THE PURPOSE SPECIFIED IN APPLICATION CHARTS. Tech Support 1-888-565-9632

Part No.	Make/Model	Loc	Year
B6270	Mercedes-Benz-CL500, CL55 AMG, CL600, CL65 AMG	Hood	2007-00
E6272	BMW-525i, 530i, 535i, 540i, M5	Trunk Lid	1995-89
E6274	Saab-9-3	Deck Lid	2011-04
D6275	Volkswagen-Golf	Hatch	2014-99
D6276	Mercedes-Benz-CLK320, CLK430, CLK55 AMG	Hood	2003-98
E6277	Volvo-1800	Back Glass	1973-72
E6278	Volvo-V70, XC70	Hatch	2007-01
E6279	Volvo-S40	Trunk Lid	2009-05
F6280	Ferrari-512 TR, Testarossa	Hood	1994-85
F6281	Porsche-Boxster	Deck Lid	2009-97
E6282	Audi-A4, A4 Quattro, A6, A6 Quattro, RS4, S4, S6	Trunk Lid	2011-04
C6283	BMW-323i, 325i, 325xi	Hatch	2005-00
E6284	Audi-90, 90 Quattro	Trunk Lid	1995-93
E6285	Chevrolet-Monte Carlo	Trunk Lid	1999
D6286	Chrysler-PT Cruiser	Deck Lid	2008-05
E6287	Hyundai-XG350	Trunk Lid	2005-02
E6288	Hummer-H3, H3T	Hood	2010-06
C6289	Hummer-H3	Door	2010-06
D6291	Audi-A4, A4 Quattro, S4	Hatch	2008-02
E6292	Audi-A4	Trunk Lid	2009-03
E6293	Mercedes-Benz-E320	Hatch	2003-98
E6294	Audi-A8 Quattro, S8	Hood	2013-04
C6295	Nissan-Armada, Pathfinder Armada	Liftgate	2015-04
E6296	INFINITI-G25, G35, G37, Q40	Hood	2015-08
F6297	INFINITI-G37	Trunk Lid	2013-09
C6299	Buick-LaCrosse	Hood	2013-10
D6301	Lexus-LS400	Hood	2000-98
E6302	Jaguar-X-Type	Hood	2008-02
E6303	Chrysler-300 Dodge-Charger, Magnum	Hood Hood	2010-05 2010-05
E6304	Jeep-Grand Cherokee	Hood	2010-05
C6305	Kia-Sorento	Hood	2009-03
D6306	Lincoln-Navigator	Hood	2006-03
B6307	Cadillac-CTS	Hood	2007-03
C6308	Lexus-SC300, SC400	Hood	2000-92
C6309	Mini-Cooper	Hood	2006-02
C6310	Chevrolet-HHR	Hood	2011-06
C6311	Kia-Amanti	Hood	2006-04
D6312	Dodge-Dakota Mitsubishi-Raider	Hood Hood	2012-04 2009-06
D6313	INFINITI-I30, I35	Hood	2004-00
E6314	Kia-Sedona	Hood	2005-03
C6315	Chevrolet-Monte Carlo Pontiac-Grand Prix	Hood Hood	2005 2005
B6316	Audi-A4, A4 Quattro, S4	Hood	2002-96

Part No.	Make/Model	Loc	Year
D6317	INFINITI-Q45	Hood	2001-97
D6318	Lincoln-Aviator	Hood	2005-03
F6319	Mercedes-Benz-GL450, ML320, ML350, ML430, ML500, ML55 AMG	Hood	2007-98
D6320	Hyundai-XG300, XG350	Hood	2005-01
C6321	Chevrolet-Cobalt Pontiac-G5, Pursuit	Hood Hood	2010-05 2009-05
E6322	Acura-CL, TL	Hood	2003-99
C6323	Mercedes-Benz-CLS400, CLS500, CLS55 AMG, CLS550, CLS63 AMG, E320, E350, E500, E55 AMG, E550, E63 AMG, S350, S500, S600, S63 AMG, S65 AMG, SL550	Hood	2016-03
D6324	Volvo-XC90	Hood	2014-03
D6325	Pontiac-Torrent Suzuki-XL-7	Hood Hood	2009-06 2009-07
E6326	Hyundai-Entourage Kia-Sedona	Hood Hood	2008-07 2012-06
C6327	Chrysler-TC Maserati	Hood	1991-89
E6328	Nissan-Murano	Hood	2007-03
D6329	Kia-Optima	Hood	2005-03
E6330	Chevrolet-Corvette	Hood	2013-05
C6331	Pontiac-Grand Prix	Hood	2008-05
C6332	Acura-MDX	Hood	2006-01
B6333	Toyota-Camry	Hood	2011-07
B6336	Hyundai-Sonata	Hood	2010-06
C6337	Saab-9-3	Hood	2003-01
C6339	Acura-MDX	Hood	2013-07
A6340	Audi-A6, A6 Quattro, S6	Hood	1997-95
E6341	BMW-318i, 318is, 323i, 323is, 325is, 328i, 328is, M3	Hood	1999-92
A6343	Mercedes-Benz-SLK230, SLK32 AMG, SLK320	Hood	2004-98
C6346	Volvo-940, 960	Hood	1997-91
D6350	Jaguar-S-Type	Hood	2008-00
E6351	Acura-TL	Hood	2008-04
D6352	Hyundai-Tiburon	Hood	2008-03
D6353	Saturn-Aura	Hood	2007
D6354	Audi-A8, A8 Quattro, S8	Hood	2003-97
D6355	Toyota-FJ Cruiser	Hood	2010-07
D6357	Pontiac-Solstice Saturn-Sky	Hood Hood	2009-06 2010-07
C6358	Land Rover-LR3, LR4, Range Rover Sport	Hood	2016-05
E6359	BMW-X3	Hood	2010-04
C6360	Mercedes-Benz-C230, C240, C280, C32 AMG, C320, C350, C55 AMG, CL55 AMG	Hood	2009-01
C6361	Lexus-RX350, RX400h	Hood	2009-07
B6362	Mercedes-Benz-S430, S500, S55 AMG, S600	Hood	2006-00
E6363	Ferrari-328 GTB, 328 GTS	Trunk Lid	1989-85

GAS CHARGED LIFT SUPPORTS ARE DESIGNED TO BE USED EXCLUSIVELY FOR THE PURPOSE SPECIFIED IN APPLICATION CHARTS.

Tech Support 1-888-565-9632

BUYER'S GUIDE / GUÍA DEL COMPRADOR / GUIDE DE L'ACHETEUR



Part No.	Make/Model	Loc	Year
F6364	Porsche-911	Hood	2013-99
E6365	INFINITI-FX35, FX45	Hood	2008-03
F6366	Ferrari-348 GTB, 348 GTS, 348 Spider, 348 TB, 348 TS	Trunk Lid	1995-89
D6367	Audi-A6 Quattro	Hatch	2004-99
C6368	BMW-318ti	Hatch	1999-95
C6369	Audi-100, A6	Hatch	1997-94
C6370	Maserati-Quattroporte	Hood	1986-79
C6371	Mazda-3	Hatch	2009-04
E6372	Chrysler-300	Hood	2010-09
E6373	Chrysler-300	Trunk Lid	2010-09
E6374	INFINITI-FX35, FX37, FX50, QX70	Hood	2017-09
D6375	INFINITI-FX35, FX50	Hatch	2013-08
C6376	Cadillac-SRX	Hood	2016-10
C6377	Cadillac-SRX	Liftgate	2016-10
E6378	Dodge-Challenger	Hood	2021-08
D6379	Jeep-Grand Cherokee	Hatch	2010-08
C6380	Jeep-Liberty	Hatch	2009-08
C6381	Jeep-Liberty	Hatch	2013-09
D6382	Jeep-Liberty	Back Glass	2013-09
E6383	Saab-9-5	Hatch	2009-99
E6393	Ford-Fusion	Trunk Lid	2009-07
	Lincoln-MKZ	Trunk Lid	2007
	Mercury-Milan	Trunk Lid	2009-07
C6399	Chevrolet-Traverse	Hood	2017-13
E6403	Jaguar-X-Type	Trunk Lid	2008-02
E6404	Cadillac-CTS	Trunk Lid	2007-03
E6405	Chrysler-300	Trunk Lid	2008-05
D6406	Dodge-Viper	Trunk Lid	2010-03
E6407	Kia-Amanti	Trunk Lid	2006-04
E6408	Ford-Mustang	Trunk Lid	2014-05
	Volkswagen-Derby	Trunk Lid	2009-95
E6409	Chevrolet-Cobalt	Trunk Lid	2010-05
E6409	Pontiac-G5, Pursuit	Trunk Lid	2009-05
F6410	Mazda-3	Trunk Lid	2009-04
F6411	Volkswagen-Cabrio	Deck Lid	2002-95
E6412	Pontiac-G6	Trunk Lid	2010-05
E6413	Oldsmobile-Intrigue	Trunk Lid	2002-99
E6414	Cadillac-CTS	Trunk Lid	2003
E6415	Lexus-LS430	Trunk Lid	2006-01
E6418	INFINITI-G20	Trunk Lid	2002-99
E6419	INFINITI-G35	Trunk Lid	2008-03
D6421	Audi-TT, TT Quattro	Trunk Lid	2006-00
E6423	Lexus-SC430	Trunk Lid	2010-02
F6425	Volkswagen-Beetle	Deck Lid	2008-03
D6426	Audi-100, 100 Quattro, A6, A6 Quattro, S4, S6	Trunk Lid	1998-92
F6427	Mazda-RX-8	Trunk Lid	2011-04

Part No.	Make/Model	Loc	Year
E6428	Hyundai-Sonata	Trunk Lid	2010-06
F6429	Nissan-Sentra	Trunk Lid	2012-07
E6430	Volkswagen-Jetta	Trunk Lid	2010-06
D6431	Audi-A8 Quattro, S8	Trunk Lid	2003-97
F6432	Volvo-S60	Trunk Lid	2009-01
F6434	Pontiac-GTO	Trunk Lid	2006-04
D6435	Volvo-940	Trunk Lid	1995-91
E6436	Ford-Focus	Trunk Lid	2011-00
E6437	BMW-323Ci, 325Ci, 330Ci, M3	Deck Lid	2006-00
C6438	BMW-Z3	Hatch	2002-99
C6439	Jaguar-XJS	Trunk Lid	1996-92
F6441	Ferrari-Mondial, Mondial 3.2, Mondial 8, Mondial t	Trunk Lid	1993-80
F6442	Mercedes-Benz-CLK320, CLK430, CLK55 AMG	Trunk Lid	2003-99
B6444	Audi-A4, A4 Quattro, RS4, S4	Hood	2009-02
C6445	INFINITI-QX56	Liftgate	2010-04
	Nissan-Armada	Liftgate	2015-05
E6446	Audi-TT, TT Quattro	Hood	2006-00
C6447	Ford-Freestar	Liftgate	2007-04
	Mercury-Monterey	Liftgate	2007-04
C6450	Hyundai-Tucson	Liftgate	2021-16
D6451	Dodge-Journey	Hatch	2020-09
C6452	Toyota-Avalon	Hood	2012-05
D6453	Ford-Freestyle	Tailgate	2006-05
B6454	Hyundai-Genesis Coupe	Hood	2016-10
D6455	INFINITI-M45	Hood	2006-03
E6457	Ford-Mustang	Trunk Lid	2014-05
C6462	Chevrolet-Traverse	Hood	2012-09
D6463	Chevrolet-Traverse	Hatch	2017-09
B6466	Toyota-Solara	Hood	2008-04
D6467	Volkswagen-Tiguan, Tiguan Limited	Hatch	2018-09
C6469	Dodge-Durango	Hatch	2013-11
C6470	Chevrolet-Equinox	Hood	2017-10
E6471	INFINITI-G37, Q60	Hood	2015-08
F6472	INFINITI-G37	Trunk Lid	2011-08
E6473	INFINITI-EX35, EX37, QX50	Hood	2017-08
D6475	Kia-Borrego	Hood	2011-09
D6476	Kia-Borrego	Hatch	2011-09
B6477	Lexus-ES350	Hood	2012-07
E6478	Nissan-Maxima	Hood	2014-09
F6479	Nissan-Maxima	Trunk Lid	2014-09
E6480	Pontiac-Vibe	Hatch	2010-09
E6481	BMW-525i, 525xi, 528i, 528i xDrive, 528xi, 530i, 530xi, 535i, 535i xDrive, 535xi, 545i, 550i, M5	Hood	2010-04
D6482	Smart-Fortwo	Back Glass	2016-05
B6483	Buick-Regal	Hood	2017-11

GAS CHARGED LIFT SUPPORTS ARE DESIGNED TO BE USED EXCLUSIVELY FOR THE PURPOSE SPECIFIED IN APPLICATION CHARTS. Tech Support 1-888-565-9632

Part No.	Make/Model	Loc	Year
E6484	Ford-F-150	Hood	2014-09
C6485	Dodge-Durango	Hood	2022-11
	Jeep-Grand Cherokee	Hood	2022-11
B6486	Jeep-Grand Cherokee	Liftgate	2013-11
E6487	Jeep-Grand Cherokee	Back Glass	2013-11
D6488	Kia-Amanti	Hood	2009-07
E6489	Hyundai-Sonata	Hood	2014-11
D6490L	Nissan-Tiida, Versa	Hatch	2012-07
D6490R	Nissan-Tiida, Versa	Hatch	2012-07
C6491	Chevrolet-Chevy	Hatch	2010-03
D6492	Chevrolet-Corsa	Hatch	2008-02
D6493	Chevrolet-Meriva	Hatch	2008-04
F6494	Chevrolet-Vectra	Hatch	2008-03
D6495	Chevrolet-Matiz	Hatch	2015-11
C6496	Chevrolet-Vectra	Hood	2008-03
C6497	Chevrolet-Chevy	Hood	2012-09
C6498	Volkswagen-Pointer	Trunk Lid	2009-06
C6499	Volkswagen-Pointer	Trunk Lid	2005-98
E6500	Chevrolet-Aveo, Aveo5	Hatch	2011-04
	Pontiac-G3, Wave	Hatch	2010-05
C6501	Honda-Civic	Hatch	2005-02
D6502	Ford-Focus	Hatch	2007-03
C6503	Hummer-H2	Liftgate	2009-03
D6504	Suzuki-Reno	Hatch	2008-05
D6508	Chevrolet-Corvette	Hatch	2013-05
D6509L	Toyota-Celica	Hatch	2005-00
D6509R	Toyota-Celica	Hatch	2005-00
D6510	Chevrolet-Malibu	Hatch	2007-04
D6512	Saab-9000	Hatch	1998-97
C6513	Acura-MDX	Hatch	2013-07
C6514	Subaru-Impreza	Hatch	1997-93
C6516	Hyundai-Accent	Hatch	2005-03
A6517L	Kia-Spectra	Hatch	2004-00
A6517R	Kia-Spectra	Hatch	2004-00
D6518	Hyundai-Elantra	Hatch	2006-01
C6519	Mazda-6	Hatch	2008-04
D6522	Chevrolet-Corvette	Hatch	2013-05
A6523	Hyundai-Tiburon	Hatch	2001-00
C6524	Chevrolet-Chevy	Hatch	2008-03
C6525	Mercedes-Benz-C230, C320	Hatch	2005-02
D6526	Audi-A4 Quattro, S4	Hatch	2002-99
D6527	Audi-Allroad Quattro	Tailgate	2005-01
E6528	Porsche-911, Boxster	Trunk Lid	2013-99
F6529	Pontiac-Aztek	Tailgate	2005-01
E6530	Volvo-C70	Trunk Lid	2004-99
F6531	Ferrari-Mondial, Mondial 3.2, Mondial 8, Mondial t	Hood	1993-80

Part No.	Make/Model	Loc	Year
E6533	BMW-M3	Hood	2006-01
E6534	Audi-80, 90, 80 Quattro, 90 Quattro	Trunk Lid	1995-88
F6535	Volkswagen-Polo	Trunk Lid	2007-03
D6536	Volkswagen-Polo	Hood	2006-03
C6537	Peugeot-206	Tailgate	2009-04
D6538	Peugeot-206	Hatch	2009-04
D6539	Dodge-Atos	Hatch	2012-05
F6540	Ford-Fiesta	Trunk Lid	2008-03
C6541	Ford-Fiesta	Hatch	2008-03
D6542	Ford-EcoSport	Hatch	2012-04
D6543	Ford-Ka	Hatch	2008-01
E6544	Ford-Mondeo	Trunk Lid	2007-01
F6545	Ford-Mondeo	Hood	2007-01
C6546	Ford-Fiesta	Hatch	2001-98
D6548	Seat-Ibiza	Trunk Lid	2011-03
E6549	Ford-Police Interceptor Sedan, Special Service Police Sedan, Taurus	Trunk Lid	2019-10
C6550	Toyota-4Runner	Liftgate	2022-10
C6553	Ford-Flex	Hood	2019-09
	Mini-Cooper	Hood	2016
D6554	Chevrolet-Astra	Hatch	2003-01
D6555	Dodge-Atos	Hatch	2004-01
E6556	Chevrolet-Caprice	Trunk Lid	2017-11
	Pontiac-G8	Trunk Lid	2009-08
D6557	Pontiac-G8	Hood	2009-08
E6558	Chevrolet-Astra	Hood	2003-01
	Chrysler-300	Hood	2021-11
	Dodge-Charger	Hood	2021-11
E6558	Ram-Dakota	Hood	2011
E6559	Ford-Police Interceptor Sedan, Special Service Police Sedan, Taurus	Trunk Lid	2019-10
D6560	Ford-Police Interceptor Sedan, Police Responder Hybrid, Special Service Police Sedan, SSV Plug-In Hybrid, Taurus	Hood	2019-10
C6562	Lincoln-MKS	Hood	2012-09
E6563	Lincoln-MKS	Trunk Lid	2012-09
F6564	Nissan-350Z	Deck Lid	2009-04
F6565	Audi-90 Quattro	Trunk Lid	1992-88
B6567	Saab-9-3, 9-3X	Hood	2011-03
B6569	Audi-A6, A6 Quattro, S6	Hood	2010-05
F6570	Audi-A6, A6 Quattro	Trunk Lid	2006-05
E6571	Audi-A8 Quattro, S8	Trunk Lid	2010-04
F6572	Audi-Cabriolet	Deck Lid	1998-94
E6573	Audi-TT, TT Quattro	Deck Lid	2006-01
E6577	BMW-645Ci, 650i, M6	Hood	2010-04
C6578	BMW-M3, Z3	Trunk Lid	2002-99
D6579	Saab-9000	Hatch	1998-94
C6580	BMW-Z8	Hood	2003-00

GAS CHARGED LIFT SUPPORTS ARE DESIGNED TO BE USED EXCLUSIVELY FOR THE PURPOSE SPECIFIED IN APPLICATION CHARTS.

Tech Support 1-888-565-9632

BUYER'S GUIDE / GUÍA DEL COMPRADOR / GUIDE DE L'ACHETEUR



Part No.	Make/Model	Loc	Year
F6581	BMW-Z8	Deck Lid	2003-00
A6582	Buick-LeSabre	Hood	2005
F6583	Jaguar-XK8, XKR	Trunk Lid	2007-00
E6584	Jaguar-XK8, XKR	Trunk Lid	2006-00
C6585	Jaguar-XK, XK8, XKR, XKR-S	Hood	2015-97
D6586	Jaguar-XJS	Hood	1996-92
C6588	Mercedes-Benz-C230, C320	Trunk Lid	2005-02
D6589	Mercedes-Benz-C240	Hatch	2005-01
F6590	Mercedes-Benz-CLK320	Trunk Lid	2005-04
F6591	Mercedes-Benz-CLK320	Trunk Lid	2005-04
F6592	Mercedes-Benz-CLK55 AMG, CLK550, CLK63 AMG	Trunk Lid	2009-04
E6594	Mercedes-Benz-E320, E500, E55 AMG, E63 AMG	Hatch	2007-04
C6595	Pontiac-Bonneville	Hood	2005
F6597	Porsche-911	Hood	2003
C6598	Porsche-Cayenne	Hood	2012-03
C6599	Volkswagen-Corrado	Hood	1992-90
E6600	Ford-Excursion	Back Glass	2005-00
E6601	Jeep-Grand Cherokee	Back Glass	2010-05
C6602	Jeep-Wrangler	Back Glass	2010-07
E6603	Kia-Sorento	Back Glass	2009-03
E6604	Honda-CR-V	Back Glass	2006-02
D6605	Lincoln-Aviator	Back Glass	2005-03
D6606	Pontiac-Vibe	Back Glass	2008-03
E6607	Nissan-Pathfinder	Back Glass	2012-05
D6609	Ford-Explorer	Back Glass	2004
	Mercury-Mountaineer	Back Glass	2004
C6610	Chevrolet-Astro	Back Glass	2005-01
	GMC-Safari	Back Glass	2005-01
E6611	Hyundai-Tucson	Back Glass	2009-05
D6612	INFINITI-QX56	Back Glass	2010-04
	Nissan-Armada, Pathfinder Armada	Back Glass	2015-04
D6613	Toyota-FJ Cruiser	Back Glass	2014-07
D6614	Land Rover-LR3, LR4	Back Glass	2016-05
D6615	Ford-Explorer	Back Glass	2010-06
	Mercury-Mountaineer	Back Glass	2010-08
D6616	BMW-X5	Back Glass	2006-00
E6617	Volkswagen-Touareg	Back Glass	2010-04
C6618	Volvo-V40	Hatch	2004-00
D6619	Land Rover-Range Rover	Hatch	2012-03
D6620	Audi-A6 Quattro	Hatch	2000-99
E6622	Audi-A6, A6 Quattro, RS6	Trunk Lid	2004-99
D6624	Ford-Explorer	Back Glass	2005
	Mercury-Mountaineer	Back Glass	2007-05
D6625	Volkswagen-Passat	Hatch	1997-96
E6627	Volkswagen-Phaeton	Hood	2006-04
E6628	Volkswagen-Phaeton	Trunk Lid	2006-04

Part No.	Make/Model	Loc	Year
D6629	Volkswagen-Touareg	Hood	2010-04
B6630	Volvo-C30, C70, S40, V50	Hood	2013-05
E6631	Volvo-S80	Trunk Lid	2006-00
D6632	Volvo-V50	Hatch	2009-05
E6634	Mercedes-Benz-SL500, SL55 AMG, SL600, SL65 AMG	Deck Lid	2008-03
E6637	Audi-TT, TT Quattro	Hatch	2006-00
C6638	Saab-9-3	Hatch	2002-99
D6639	Nissan-Almera	Hatch	2005-01
D6640	Nissan-X-Trail	Liftgate	2007-02
D6643	Audi-Allroad Quattro	Tailgate	2005-01
F6645	Nissan-NV1500, NV2500, NV3500	Hood	2021-12
C6646	Ford-F-250 Super Duty, F-350 Super Duty, F-450 Super Duty, F-550 Super Duty	Hood	2016-11
E6647	Ford-Expedition	Hood	2017-08
D6648	Honda-Pilot	Liftgate	2015-09
D6649	Honda-Pilot	Back Glass	2015-09
E6650	BMW-325i, 325xi, 328i, 328i xDrive, 328xi, 330i, 330xi, 335d, 335i, 335i xDrive, 335is, 335xi	Hood	2012-06
E6651	BMW-325i, 325xi, 328i, 328i xDrive, 328xi, 330i, 330xi, 335d, 335i, 335i xDrive, 335is, 335xi, M3	Trunk Lid	2013-06
D6652	Kia-Soul	Liftgate	2013-10
D6653	Lexus-GS300, GS350, GS430, GS450h, GS460	Hood	2011-05
E6654	Lexus-GS350, GS450h, GS460	Trunk Lid	2011-07
B6655	Toyota-Sequoia, Tundra	Hood	2018-07
C6656	Toyota-Sequoia	Hatch	2021-08
E6657	Dodge-Challenger	Trunk Lid	2021-08
D6658	Lexus-CT200h	Hatch	2012-11
D6659	Dodge-Ram 1500	Hood	2010-09
	Ram-1500, 2500, 1500 Classic	Hood	2021-11
C6660	Acura-RDX	Hatch	2012-07
D6661	Mazda-CX-9	Hatch	2015-07
D6663	Honda-Pilot	Liftgate	2015-09
B6664	Jeep-Grand Cherokee	Liftgate	2013-11
C6665	Honda-CR-V	Hatch	2016-12
E6666	Chevrolet-Spark, Spark EV	Hatch	2016-13
D6667	Fiat-500	Hatch	2019-12
C6670	Ford-Flex	Liftgate	2012-09
E6671	Ford-Fusion	Trunk Lid	2007-06
E6672	Chevrolet-Impala, Impala Limited	Trunk Lid	2016-09
C6673	Hyundai-Genesis	Hood	2013-09
D6674	Nissan-370Z	Hatch	2016-09
E6675	Ford-Fusion	Trunk Lid	2012-10
E6675	Lincoln-MKZ	Trunk Lid	2012-10
	Mercury-Milan	Trunk Lid	2011-10
F6676	Volvo-XC60	Hood	2017-10

GAS CHARGED LIFT SUPPORTS ARE DESIGNED TO BE USED EXCLUSIVELY FOR THE PURPOSE SPECIFIED IN APPLICATION CHARTS. Tech Support 1-888-565-9632

Part No.	Make/Model	Loc	Year
C6677	Volvo-XC60	Hatch	2017-10
D6678	Jeep-Wrangler, Wrangler JK	Back Glass	2018-11
E6679	Chrysler-200, Sebring	Trunk Lid	2014-09
D6680	Toyota-Venza	Liftgate	2016-09
C6681	Ford-Explorer, Police Interceptor Utility	Hatch	2015-11
D6682	Hyundai-Santa Fe	Hood	2012-07
D6683	Hyundai-Santa Fe	Liftgate	2012-07
C6684	Lincoln-MKX	Hatch	2010-07
D6685	Mazda-5	Hatch	2015-12
B6686	Ford-Escape	Tailgate	2017-13
B6687	Ford-Escape	Tailgate	2017-13
C6688	Toyota-Sequoia	Liftgate	2021-08
A6689	Mercedes-Benz-G500, G55 AMG, G550, G63 AMG, G65 AMG	Hood	2018-02
C6690	Mercedes-Benz-SLK280, SLK300, SLK350, SLK55 AMG	Hood	2011-05
C6691	Land Rover-Range Rover	Hood	2002-96
D6692	Audi-Q7	Hood	2015-07
C6693	Mercedes-Benz-ML320, ML350, ML450, ML550, ML63 AMG	Hatch	2011-06
E6694	Nissan-Titan	Tailgate	2015-04
E6695	INFINITI-M45	Trunk Lid	2004-03
F6696	BMW-525i, 528i, 540i	Back Glass	2003-99
E6697	BMW-750iL	Hood	2001-95
F6698	Mercedes-Benz-SL500, SL600	Deck Lid	2002-94
E6699	Mercedes-Benz-SL500, SL55 AMG, SL550, SL600, SL65 AMG	Hood	2008-03
F6700	Mercedes-Benz-SLR McLaren	Trunk Lid	2006-05
D6701	Mazda-2	Hatch	2014-11
D6702L	Chevrolet-Corvette	Hatch	2004-97
D6702R	Chevrolet-Corvette	Hatch	2004-97
D6708	Kia-Sportage	Liftgate	2016-11
C6711	Chevrolet-Malibu, Malibu Limited	Hood	2016-13
D6713	Chevrolet-Malibu, Malibu Limited	Trunk Lid	2016-13
D6715	Kia-Sportage	Liftgate	1999-95
C6733	Volkswagen-Beetle	Hatch	2019-12
E6734	Hyundai-Veloster	Hatch	2016-12
F6735	Mazda-MX-5 Miata	Deck Lid	2015-06
B6738	Chevrolet-Impala	Hood	2020-14
D6739	Dodge-i10	Hatch	2014-12
F6740	Saab-9-3	Trunk Lid	2003-99
D6741L	Toyota-Land Cruiser	Hatch	1997-91
D6741R	Toyota-Land Cruiser	Hatch	1997-91
D6743	Fiat-Palio	Hatch	2006-04
D6744	Fiat-Palio	Hatch	2008-07
D6745	Ford-EcoSport	Hatch	2021-13
D6746	Honda-Fit	Hatch	2014-09
C6747	Nissan-X-Trail	Hatch	2013-08

Part No.	Make/Model	Loc	Year
D6748	Peugeot-307	Hatch	2009-03
D6749	Renault-Clio	Hatch	2010-02
D6750	Renault-Kangoo Express	Hatch	2014-04
A6752	Seat-Toledo	Hatch	2006-05
D6753	Ford-Taurus	Hood	2009-07
C6754	Lexus-RX350, RX450h	Liftgate	2012-10
D6755	Lexus-RX350, RX450h	Hood	2015-10
C6756	Lexus-RX350, RX450h	Tailgate	2015-10
C6757	Toyota-Avalon, Camry	Hood	2018-12
D6759	Scion-FR-S	Trunk Lid	2016-13
E6760	Lincoln-MKS	Trunk Lid	2016-13
D6761	Toyota-4Runner	Hood	2021-10
D6762	Toyota-Highlander	Liftgate	2013-08
C6763	Toyota-Sienna	Liftgate	2020-11
C6764	GMC-Terrain	Liftgate	2015-10
C6765	Kia-Optima	Hood	2015-11
B6766	GMC-Acadia, Acadia Limited	Hood	2017-13
C6767	Ford-F-250 Super Duty, F-350 Super Duty, F-450 Super Duty, F-550 Super Duty	Hood	2010-08
E6768	BMW-X5, X6	Hood	2014-07
D6769	Honda-Accord Crosstour, Crosstour	Hood	2015-10
D6770	Honda-Accord Crosstour, Crosstour	Hatch	2015-10
E6771	INFINITI-M35, M45	Hood	2010-06
E6772	INFINITI-M35, M45	Trunk Lid	2010-06
D6773	Honda-Fit	Hatch	2008-06
F6774	Pontiac-G6	Deck Lid	2009-06
B6775	Jeep-Grand Cherokee	Liftgate	2016-14
C6776	Lincoln-MKT	Hood	2019-10
C6777	Lincoln-MKT	Tailgate	2019-10
D6778	Hyundai-Accent	Hatch	2017-12
C6779	Lexus-LS460, LS600h	Hood	2012-07
B6780	Nissan-Quest	Liftgate	2017-11
D6781L	Toyota-Land Cruiser	Hatch	1990
D6781R	Toyota-Land Cruiser	Hatch	1990
D6782	Jaguar-XF, XFR, XFR-S	Hood	2015-09
E6783	Jaguar-XF, XFR, XFR-S	Trunk Lid	2015-09
C6784	Chevrolet-SS	Hood	2017-14
E6785	Chevrolet-SS	Trunk Lid	2017-14
F6786	Mazda-3	Trunk Lid	2013-10
D6787	Chevrolet-Sonic	Hatch	2019-12
C6791	Ford-Fiesta	Hatch	2019-11
C6792	Buick-LaCrosse	Hood	2009-08
C6796	Volkswagen-Beetle	Hatch	2019-12
D6797	Lexus-IS250, IS350	Hood	2015-06
E6798	Lexus-IS F, IS250, IS350	Trunk Lid	2015-10
C6799	Hyundai-Elantra GT	Hatch	2017-13
D6800	Mazda-3	Hatch	2009-07

GAS CHARGED LIFT SUPPORTS ARE DESIGNED TO BE USED EXCLUSIVELY FOR THE PURPOSE SPECIFIED IN APPLICATION CHARTS.

Tech Support 1-888-565-9632

BUYER'S GUIDE / GUÍA DEL COMPRADOR / GUIDE DE L'ACHETEUR



Part No.	Make/Model	Loc	Year
C6801	INFINITI-Q50	Hood	2019-14
E6802	INFINITI-Q50	Trunk Lid	2021-14
D6803	Ford-Mustang	Trunk Lid	2004-94
E6807	Volkswagen-Passat	Trunk Lid	2017-12
B6808	Volkswagen-Passat	Hood	2019-13
C6809	GMC-Terrain	Liftgate	2017-10
F6817	Chevrolet-Camaro	Deck Lid	2013-11
D6819	Volkswagen-Lupo	Tailgate	2009-05
D6824	Seat-Leon	Hatch	2009-07
E6826	Acura-TL	Hood	2014-09
C6827	Chevrolet-Equinox	Liftgate	2016-10
D6831	Jeep-Patriot	Hatch	2016-07
D6832	Mitsubishi-Endeavor	Liftgate	2011-10
F6833	Nissan-Altima	Trunk Lid	2013-08
B6834	Volkswagen-CC	Hood	2017-09
F6835	Porsche-Cayenne	Back Glass	2010-03
D6837	Subaru-Legacy, Outback	Hood	2014-10
F6839	INFINITI-G37, Q60	Deck Lid	2015-11
C6840	BMW-328i, 335i, 335is, M3	Trunk Lid	2013-07
D6842	Toyota-RAV4	Hatch	2016-13
E6843	Subaru-Legacy	Trunk Lid	2014-10
C6845	BMW-X3	Hatch	2017-11
E6846	BMW-X3, X4	Hood	2018-11
E6847	INFINITI-JX35, QX60	Hood	2020-13
D6848	Buick-LaCrosse	Trunk Lid	2013-10
E6849	Cadillac-CTS	Hatch	2014-10
E6850	INFINITI-Q45	Hood	2006-05
E6851	Volkswagen-CC	Trunk Lid	2017-09
E6852	Mercedes-Benz-R320, R350, R500, R63 AMG	Hood	2010-06
D6853	Mercedes-Benz-R320, R350, R500, R63 AMG	Hood	2010-06
D6855	Toyota-FJ Cruiser	Hood	2014-11
D6859	Volkswagen-Golf, GTI	Hatch	2014-10
E6861	Ford-F-150, Lobo	Hood	2020-15
E6862	Ford-F-150, Lobo	Hood	2020-15
D6863	Chrysler-200	Hood	2017-15
F6866	Chevrolet-Camaro	Trunk Lid	2015-10
C6867	BMW-328i, 335i, 335is, M3	Deck Lid	2013-07
D6868	Cadillac-ATS	Hood	2019-13
D6869	Cadillac-Escalade, Escalade ESV	Back Glass	2020-15
	Chevrolet-Suburban, Suburban 3500 HD, Tahoe	Back Glass	2020-15
	GMC-Yukon, Yukon XL	Back Glass	2020-15
F6870	BMW-740i, 740Li, 750i, 750i xDrive, 750Li, 750Li xDrive, 760Li, Alpina B7, Alpina B7 xDrive, Alpina B7L, Alpina B7L xDrive	Hood	2012-11
C6871	Nissan-Versa Note	Hatch	2019-14

Part No.	Make/Model	Loc	Year
C6873	Hyundai-Equus	Hood	2016-11
F6874	Chevrolet-Camaro	Deck Lid	2015-14
C6875	Buick-Encore	Liftgate	2018-13
D6876	Kia-Sorento	Liftgate	2015-14
E6877	Hyundai-Santa Fe, Santa Fe Sport, Santa Fe XL	Hood	2019-13
D6878	Hyundai-Santa Fe Sport	Liftgate	2015-13
D6879	INFINITI-Q45	Hood	2004-02
E6880	Jeep-Cherokee	Hood	2019-14
C6881	Jeep-Cherokee	Liftgate	2019-14
C6882	Lincoln-MKX	Liftgate	2015-11
D6883	Hyundai-Tucson	Liftgate	2016-10
D6884	Nissan-March	Hatch	2015-12
C6888	Toyota-Sienna	Liftgate	2020-11
C6900	Chevrolet-Express 1500, Express 2500, Express 3500	Cargo Van Access Panel	2019-03
	GMC-Savana 1500, Savana 2500, Savana 3500	Cargo Van Access Panel	2019-03
D6901	Chevrolet-Express 1500, Express 2500, Express 3500, Express 4500	Door	2019-03
	GMC-Savana 1500, Savana 2500, Savana 3500, Savana 4500	Door	2019-03
E6902	Chevrolet-SSR	Deck Lid	2006-03
F6904	Dodge-Durango	Truck Bed Storage Box Lid	2003-98
E6911	Nissan-Xterra	Top Stowage Compartment	2015-05
E6922	Jaguar-Vanden Plas, XJ12, XJ6, XJ8, XJR	Deck Lid	2003-95
F6952	Cadillac-Allante	Convertible Top Cover	1993-90
E7001	INFINITI-M35h, M37, M56	Trunk Lid	2013-11
C7003	Nissan-Juke	Hatch	2017-11
C7004	Hyundai-Entourage	Hatch	2008-07
	Mazda-3	Hatch	2018-14
D7005	Kia-Optima	Hood	2020-16
E7006	Mitsubishi-Lancer	Trunk Lid	2016-08
A7010	Nissan-Urvan	Liftgate	2013-00
E7011	Kia-Sorento	Hood	2020-16
D7012	Kia-Sorento	Liftgate	2020-16
C7013	Kia-Sedona	Liftgate	2014-06
C7014	Toyota-Sienna	Hatch	2005-04
C7015	Nissan-Pathfinder	Liftgate	2017-13
C7017	Hyundai-Santa Fe Sport	Liftgate	2018-15
D7018	Dodge-Ram 2500, Ram 3500	Hood	2010
	Ram-2500, 3500, 4500, 5500	Hood	2018-11
E7019	Hyundai-Genesis	Hood	2016-14
C7020	Mercedes-Benz-C180, C200, C250, C350, C63 AMG, E200, E250, E300, E350, E400, E500, E550, E63 AMG, E63 AMG S	Hood	2017-10
F7021	Mazda-MX-5 Miata	Deck Lid	2021-16

GAS CHARGED LIFT SUPPORTS ARE DESIGNED TO BE USED EXCLUSIVELY FOR THE PURPOSE SPECIFIED IN APPLICATION CHARTS. Tech Support 1-888-565-9632

Part No.	Make/Model	Loc	Year
D7022	INFINITI-QX56, QX80	Liftgate	2018-11
E7023	Chevrolet-Corvette	Hood	2019-14
E7024	Chevrolet-Corvette	Hatch	2019-14
D7025	Cadillac-CTS	Hood	2019-14
D7026	Mitsubishi-Outlander	Liftgate	2013-07
D7027	Mitsubishi-Outlander Sport	Liftgate	2015-12
E7028	Land Rover-Range Rover	Hood	2012-03
E7032	Toyota-Highlander	Back Glass	2019-14
E7033	Mercedes-Benz-AMG GT, AMG GT C, AMG GT R, AMG GT R Pro, AMG GT S, SLS AMG	Hood	2021-11
C7034	Ford-Focus	Hatch	2018-12
E7035	Land Rover-Range Rover	Hatch	2002-99
C7036	Porsche-Carrera GT	Deck Lid	2006-04
C7038	Porsche-Cayman	Hood	2012-06
C7039	Jeep-Cherokee	Liftgate	2019-15
C7040	Toyota-Highlander	Liftgate	2019-14
D7041	Chevrolet-Volt	Hatch	2015-11
C7042	Saturn-Astra	Hood	2009-08
D7044	Hyundai-Azera	Deck Lid	2011-06
C7045	Hyundai-Veracruz	Liftgate	2012-07
D7046	Jaguar-XK, XKR	Trunk Lid	2015-07
C7047	Kia-Sportage	Liftgate	2010-05
D7048	Hyundai-Elantra	Hatch	2012-09
D7049	Mini-Cooper Countryman	Hatch	2016-11
C7050	Acura-RDX	Liftgate	2017-13
D7051	Audi-Q7	Liftgate	2015-07
D7052	Mercedes-Benz-GLK250, GLK350	Hatch	2015-10
D7053	Audi-Q7	Liftgate	2015-07
E7054	BMW-128i	Hood	2013-08
E7055	Mini-Cooper	Hatch	2014-08
C7057	Land Rover-Range Rover Sport	Liftgate	2011-06
E7058	Audi-A5 Quattro, RS5, S5	Trunk Lid	2021-08
D7059	Audi-A6, A6 Quattro, S6	Trunk Lid	2018-12
E7060	Audi-A4, A4 Quattro	Trunk Lid	2016-09
C7061	Dodge-Durango	Liftgate	2016-11
C7062	Buick-LaCrosse	Hood	2016-14
E7064	Volvo-S80, V70, XC70	Hood	2016-07
E7065	Volvo-S80	Trunk Lid	2016-07
D7066	Toyota-Tundra	Tailgate	2021-07
E7067	Kia-Cadenza	Hood	2016-14
C7068	Cadillac-XTS	Hood	2017-13
D7069	Mini-Cooper	Hatch	2013-07
D7071	Scion-xB	Liftgate	2015-08
D7072	Kia-Sportage	Back Glass	2010-05
C7073	BMW-328i, 328i xDrive, 328xi	Liftgate	2012-07
C7074L	Subaru-Forester	Liftgate	2013-09

Part No.	Make/Model	Loc	Year
C7074R	Subaru-Forester	Liftgate	2013-09
C7075	Honda-Odyssey	Hatch	2017-11
E7078	Ford-Expedition	Hood	2009-07
E7079	Mitsubishi-Lancer	Trunk Lid	2016-08
D7085	Chevrolet-Impala	Trunk Lid	2020-14
E7086	INFINITI-Q50	Hood	2021-14
D7088	Toyota-Prius, Prius Plug-In	Hatch	2015-12
E7089	Lexus-SC430	Trunk Lid	2010-02
D7090	Honda-Accord	Hood	2016-13
C7091	Honda-Odyssey	Hatch	2017-11
D7092	Toyota-Yaris	Hatch	2011-07
E7094	Nissan-Murano	Hood	2022-15
D7105	Nissan-Armada	Hood	2020-17
E7118	Land Rover-Discovery Sport	Hood	2021-16
C7119	Cadillac-XTS	Hood	2019-18
C7120	Cadillac-XTS	Trunk Lid	2019-13
C7121	Audi-A4, A4 Quattro, S4	Hood	2006-03
D7122	Nissan-Armada	Liftgate	2019-17
B7123	Volkswagen-Tiguan	Hood	2020-17
C7124	Volkswagen-Tiguan	Liftgate	2020-17
E7126	BMW-X1	Hood	2015-13
C7127	BMW-X1	Liftgate	2015-10
E7128	Buick-Cascada	Trunk Lid	2019-16
E7129	Ford-Mustang	Deck Lid	2020-15
C7131	Toyota-Sienna	Liftgate	2015-11
E7132	Buick-Regal	Trunk Lid	2017-11
D7133	Toyota-Matrix	Hatch	2014-09
C7134	Hyundai-Accent	Trunk Lid	2011-07
C7135	Saturn-Outlook	Hood	2010-07
D7136	Toyota-Yaris	Hatch	2017-12
D7137	Toyota-Yaris	Hatch	2011-06
F7138	Mazda-6	Trunk Lid	2013-06
E7140	Mini-Cooper Countryman, Cooper Paceman	Hood	2016-11
D7143	Audi-Q5, SQ5	Liftgate	2017-09
E7144	Audi-A5, A5 Quattro, RS5, S5	Trunk Lid	2017-10
D7145	Kia-Forte	Hatch	2013-11
E7147	Cadillac-XLR	Trunk Lid	2009-04
F7148	Dodge-Ram 1500, Ram 2500, Ram 3500	Seat Adjustment Strut	2007-02
A7149	Audi-100, 100 Quattro, S4	Hood	1994-92
B7150	Audi-A4, A4 allroad, A4 Quattro, A5, A5 Quattro, allroad, RS5, S4, S5	Hood	2020-08
C7151	Saab-9-5	Hood	2009-06
B7154	Kia-Soul	Hood	2019-14
C7155	Acura-TLX	Hood	2020-15
C7156	Lexus-ES300h, ES350	Hood	2018-13
F7157	Chrysler-Crossfire	Deck Lid	2008-05

GAS CHARGED LIFT SUPPORTS ARE DESIGNED TO BE USED EXCLUSIVELY FOR THE PURPOSE SPECIFIED IN APPLICATION CHARTS.

Tech Support 1-888-565-9632

BUYER'S GUIDE / GUÍA DEL COMPRADOR / GUIDE DE L'ACHETEUR

Part No.	Make/Model	Loc	Year
E7159	Audi-A6, A6 Quattro, A7, A7 Quattro, RS7, S6, S7	Hood	2018-10
C7160	Land Rover-Range Rover Sport	Back Glass	2013-08
E7161	BMW-535i GT, 535i GT xDrive, 550i GT, 550i GT xDrive	Hatch	2017-10
E7162	Chevrolet-Corvette	Trunk Lid	2019-14
C7164L	Mercedes-Benz-ML320, ML350, ML450, ML550, ML63 AMG	Hood	2011-06
C7164R	Mercedes-Benz-ML320, ML350, ML450, ML550, ML63 AMG	Hood	2011-06
E7165L	Mercedes-Benz-R350	Hood	2012-11
E7165R	Mercedes-Benz-R350	Hood	2012-11
C7166	Jaguar-XJ, XJR	Hood	2019-11
C7168	Toyota-Tundra	Hood	2021-14
C7170	Toyota-Camry	Hood	2021-18
D7173	Acura-MDX	Hood	2016-14

Part No.	Make/Model	Loc	Year
C7174	Kia-Soul, Soul EV	Liftgate	2019-14
C7175L	Mercedes-Benz-GLK250, GLK280, GLK300, GLK350	Hood	2015-09
C7175R	Mercedes-Benz-GLK250, GLK280, GLK300, GLK350	Hood	2015-09
E7176	Chrysler-300	Hood	2021-11
	Dodge-Charger	Hood	2021-11
C7178	Honda-HR-V	Hatch	2018-16
D7179	Honda-Insight	Hatch	2014-10
C7180	Cadillac-SRX	Liftgate	2016-10
B7181L	Jeep-Grand Cherokee	Liftgate	2020-14
B7181R	Jeep-Grand Cherokee	Liftgate	2020-14
C7184	Chevrolet-Astra	Tailgate	2004-00
E7185	Land Rover-Range Rover Evoque	Hood	2019-12

GAS CHARGED LIFT SUPPORTS ARE DESIGNED TO BE USED EXCLUSIVELY FOR THE PURPOSE SPECIFIED IN APPLICATION CHARTS.

Tech Support 1-888-565-9632

QUICK TOOL BOX CROSS REFERENCE

REFERENCIA CRUZADA RÁPIDA PARA LA CAJA DE HERRAMIENTAS

TABLEAU DE RENVOI RAPIDE POUR LA BOÎTE À OUTILS

Part#	StrongArm	Ext	Comp	Force	End Fitting
CONTICO/TRADESMAN					
0863UC	E4125	13.0	8.4	25	Ball Socket
3332PC	F6915	10.0	6.8	45	Ball Socket
5511RI	F6915	10.0	6.8	45	Ball Socket
6083RK	E4128	13.0	8.4	100	Ball Socket
7495QQ	F4060	10.0	6.6	60	Ball Socket
7835PB	F6915	10.0	6.8	45	Ball Socket
7981IM	F6915	10.0	6.8	45	Ball Socket
CONTINENTAL					
7292SK	F6915	10.0	6.8	45	Ball Socket
8321QX	F4060	10.0	6.6	60	Ball Socket
DEE ZEE					
4409ti	F6915	10.0	6.8	45	Ball Socket
4411tp	F4031	10.0	6.8	88	Ball Socket
DELTA					
0305UJ	F6916	10.0	6.8	82	Ball Socket
1518UU	E6918	11.0	7.4	35	Ball Socket
3901TV	E6917	11.0	7.4	26	Ball Socket
3904TG	E6180	10.8	7.3	81	Ball Socket
7921SI	E4127	13.0	8.4	65	Ball Socket
8097SS	E4126	13.0	8.4	55	Ball Socket
8767SO	E4539	13.1	9.3	121	Ball Socket
8979SL	F6915	10.0	6.8	45	Ball Socket
9008SF	F6915	10.0	6.8	45	Ball Socket
9009SA	F6915	10.0	6.8	45	Ball Socket
9022SX	F6915	10.0	6.8	45	Ball Socket
9023SS	F6915	10.0	6.8	45	Ball Socket
10229	F4671	10.0	6.8	26	Eyelets
10079	F4672	10.0	6.8	51	Eyelets
10078	F4673	10.0	6.8	71	Eyelets
10088	F4674	10.0	6.8	90	Eyelets
KNAACK					
1205IC	E6924	15.0	9.3	26	Ball Socket
1575EJ	E4420	12.0	8.1	30	Ball Socket
1591ER	D4423	17.2	11.0	30	Ball Socket
2146BA	D4423	17.2	11.0	30	Ball Socket
3148MT	E6533	12.5	8.2	85	Ball Socket
3268PP	E4511	12.0	8.1	70	Ball Socket
3355HH	D4423	17.2	11.0	30	Ball Socket
3471HI	D4418	17.2	10.6	40	Ball Socket
5079KW	D4418	17.2	10.6	40	Ball Socket
647128	E4488	12.0	8.1	54	Ball Socket
647152	E6408	11.3	8.1	73	Ball Socket
647160	D6930	17.2	10.6	145	Ball Socket
647179	D6930	17.2	10.6	145	Ball Socket
7381IA	E4420	12.0	8.1	30	Ball Socket
7387IY	E4420	12.0	8.1	30	Ball Socket
7389IO	E4488	12.0	8.1	54	Ball Socket
7391IV	E4488	12.0	8.1	54	Ball Socket
7467IC	E4040	12.0	8.1	40	Ball Socket

Continued on Next Page

QUICK TOOL BOX CROSS REFERENCE

REFERENCIA CRUZADA RÁPIDA PARA LA CAJA DE HERRAMIENTAS
TABLEAU DE RENVOI RAPIDE POUR LA BOÎTE À OUTILS

Part#	StrongArm	Ext	Comp	Force	End Fitting
KNAACK (Continued)					
7468IY	E4488	12.0	8.1	54	Ball Socket
7469IT	E4511	12.0	8.1	70	Ball Socket
7472IV	E4511	12.0	8.1	70	Ball Socket
7473IQ	E4128	13.0	8.4	100	Ball Socket
748307	E6533	12.5	8.2	85	Ball Socket
7577IQ	D4192	17.1	11.0	22	Ball Socket
7856IM	E4420	12.0	8.1	30	Ball Socket
8232IY	D6930	17.2	10.6	145	Ball Socket
8233IT	D6930	17.2	10.6	145	Ball Socket
864137	E4040	12.0	8.1	40	Ball Socket
SNAP-ON					
1585ED	E4464	14.5	9.3	40	Ball Socket
1586EZ	E4464	14.5	9.3	40	Ball Socket
1592EM	D4418	17.2	10.6	40	Ball Socket
6501IP	F4677	8.9	6.5	27	Ball Socket
7088KF	E6604	14.0	9.2	27	Ball Socket
752819	E6921	16.0	10.0	35	Ball Socket
754722	E6604	14.0	9.2	27	Ball Socket
8264IX	E6604	14.0	9.2	27	Ball Socket
8267II	E6604	14.0	9.2	27	Ball Socket
STELLAR					
0696UK	E4420	12.0	8.1	30	Ball Socket
0697UF	E4420	12.0	8.1	30	Ball Socket
3656NL	E4420	12.0	8.1	30	Ball Socket
4191WD	E4420	12.0	8.1	30	Ball Socket
6625UJ	D4418	17.2	10.6	40	Ball Socket
UWS					
5239RE	E4683	14.5	9.3	75	Ball Socket
8322IV	F6915	10.0	6.8	45	Ball Socket
8363IV	E4683	14.5	9.3	75	Ball Socket

UNIVERSAL COVERAGE COBERTURA UNIVERSAL / COUVERTURE UNIVERSELLE

For PIU Camper Caps, Tool Boxes & Custom Applications / Para tapas de caravanas pick-up, cajas de herramientas y usos personalizados / Pour auto-caravane, boîtes à outils et les applications personnalisées

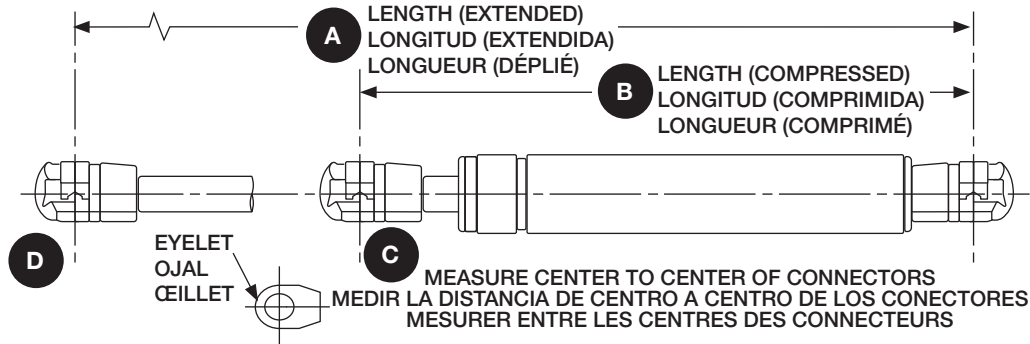

How to Select a Gas Charged Lift Support

- Measure Extended Length **A**
- Measure Compressed Length **B**:
If the spring cannot be compressed, measure the exposed shaft length **C**
- Identify end connector type **D**
- Capture all markings on the tube
- Special note pressure xxx#s or xxxN: The conversion from Newton's "N" to pounds is (xxxN/ 4.45)
- Select part number needed from specification chart

What if you are missing some key information?

- Identify application type: Tool box, truck cap, tonneau cover, sun bed, boat hatch, etc.
- Identify brand of application: Delta, Knaack, Snug Top, Bay Liner, etc.
- Call StrongArm® Tech Line at 800-790-5438

Important Facts to Remember:

- Gas springs cannot always be compressed by hand
- Replace as pairs as applicable
- Install new lift supports in the same orientation as the old ones

Universal lift supports are not application specific and they should be used only when design/application criteria is known.

Cómo seleccionar un soporte elevador de gas

- Mida la longitud extendida **A**
- Mida la longitud comprimida **B**:
Si no es posible comprimir el muelle, mida la longitud expuesta del tubo **C**
- Identifique el tipo de conector en el extremo **D**
- Registre todas las marcas en el tubo
- Tome nota, en especial, de la presión xxx#s o xxxN: La conversión de newtons ("N") a libras es (xxx N/4.45)
- Seleccione el número de parte que necesite de la tabla de especificaciones

¿Qué sucede si falta algún dato importante?

- Identifique el tipo de aplicación: Caja de herramientas, tapa trasera de camioneta, cubierta de la capota trasera, tumbona, escotilla de embarcación, etc.
- Identifique la marca de la aplicación: Delta, Knaack, Snug Top, Bay Liner, etc.
- Llame al soporte técnico de StrongArm® al 800-790-5438

Información importante que debe recordar:

- Los muelles de gas no siempre pueden comprimirse manualmente
- Deben cambiarse por pares según, sea pertinente
- Instale los nuevos soportes elevadores con la misma orientación que los anteriores

Los soportes elevadores universales no son para aplicaciones específicas y únicamente deben usarse cuando se conozcan los criterios de diseño y aplicación.

Comment choisir un support élévateur à gaz

- Mesurer la longueur étendue (tige sortie) **A**
- Mesurer la longueur comprimée (tige rentrée) **B**: S'il n'est pas possible de comprimer le support, mesurer la longueur de tige apparente **C**
- Identifier le type de point de fixation **D**
- Noter toutes les inscriptions sur le cylindre
- Valeurs de pression : xxx lb ou xxx N: Conversion des valeurs en Newton aux valeurs en livres = (xxxN/ 4.45)
- Sélectionner le numéro de pièce nécessaire à partir du tableau des spécifications

Que faire s'il manque des renseignements importants?

- Identifier l'application : Coffre à outils, capot de camion, couvre-caisse, lit de bronzage, écouteille de bateau, etc.
- Identifier la marque de l'application : Delta, Knaack, Snug Top, Bay Liner, etc.
- Appeler le soutien téléphonique StrongArm® au 800-790-5438

Autres facteurs importants :

- Il n'est pas toujours possible de comprimer à la main un support à gaz
- Toujours remplacer les deux supports à gaz à la fois
- Installer les nouveaux supports à gaz dans le même sens que les anciens

Les supports élévateurs à gaz à couverture universelle ne sont pas conçus pour une application marginale et doivent être choisis uniquement lorsque les valeurs de conception et les exigences de l'application sont connues.

UNIVERSAL COVERAGE

COBERTURA UNIVERSAL / COUVERTURE UNIVERSELLE

What makes StrongArm® universal different?

We have custom designed our parts to fit a range of lengths and pressures that maximize the efficiency of each size range; there is no need to have an exact match to an existing part.

- Choose a group size that most closely matches the length of your existing part number.
- Choose a pressure that is rounded up to the next pressure offering.
- Choose a connector that resembles your current connector type.

¿En qué se diferencian los elevadores universales StrongArm®?

Hemos diseñado nuestras piezas de forma personalizada para que se adapten a una gama de longitudes y presiones que optimizan la eficacia de cada línea de tamaños; no es necesario tener una equivalencia exacta con la pieza existente.

- Elija el tamaño grupal que más se acerque a la longitud de su número de parte existente.
- Elija una presión que esté redondeada hacia arriba, al siguiente valor de presión.
- Elija un conector que se asemeje al tipo de conector que usa actualmente.

Qu'est-ce qui rend le système universel de support élévateur StrongArm® si différent?

Nous avons personnalisé nos pièces pour qu'elles conviennent à une multitude de longueurs et de pressions dans toutes les gammes de taille pour une efficacité maximale; il n'est pas nécessaire d'avoir une correspondance exacte à une pièce existante.

- Choisir une taille de groupe se rapprochant le plus de la longueur de votre numéro de pièce existant.
- Choisir une pression arrondie à la prochaine valeur de pression supérieure.
- Choisir un connecteur qui ressemble à votre type de support actuel.

MPS hardware completes the job.

- Designed with multiple attachment holes, and slotted mounting grooves
- Mix and match – perfect for new and retrofit applications
- Heavy gauge steel provides secure installation
- Can be purchased with or without lift supports

Los componentes MPS completan la tarea

- Diseñados con diversos orificios de conexión y ranuras acanaladas de montaje
- Combinación y coincidencia: ideales para aplicaciones nuevas y adaptaciones
- El acero grueso ofrece una instalación segura
- Pueden comprarse con o sin los soportes elevadores

La quincaillerie MPS complète le travail

- Conçue avec de multiples orifices et rainures de fixation
- S'Assortit parfaitement aux applications nouvelles et de mise à niveau
- L'acier de haut calibre procure une installation sécuritaire
- Peut être achetée avec ou sans supports élévateurs

UNIVERSAL COVERAGE

COBERTURA UNIVERSAL / COUVERTURE UNIVERSELLE

Brackets / Soportes / Fixations



**Ball Stud Kits / Pernos esféricos /
Nécessaires de pivots sphériques**

Includes nuts and washers in two sizes (10 mm & 13 mm) SA3000, SA3001

Con tuercas y arandelas de dos tamaños (10 mm & 13 mm) SA3000, SA3001

Comprend les écrous et rondelles en 2 tailles (10 mm & 13 mm) SA3000, SA3001

**Shoulder Stud Kits / Pernos hexagonales /
Nécessaires de goujons d'épaulement**

Includes nuts and washers SA3002

Con tuercas y arandelas SA3002

Comprend les écrous et les rondelles SA3002

UNIVERSAL COVERAGE

COBERTURA UNIVERSAL / COUVERTURE UNIVERSELLE



(A) 10 MM BALL SOCKET
(A) RÓTULA DE 10 MM
(A) DOUILLE SPHÉRIQUE 10 MM



(B) BLADE
(B) CUCHILLA
(B) LAME



(C) 13 MM BALL SOCKET
(C) RÓTULA DE 13 MM
(C) DOUILLE SPHÉRIQUE 13 MM

Part#	Ext	Comp	Force Pounds	Force Newtons	Shaft Connector	Body Connector
Group 7 - Replaces Gas Springs with an Extended Length of 6.4" to 8.0"						
F7080	6.40	4.7	155.0	689	Blade (12.81mm Dia. Hole)	Blade (12.81mm Dia. Hole)
F4053	7.5	5.34	25	111	Ball Socket (Nylon) 10mm	Ball Socket (Nylon) 10mm
F4054	7.5	5.34	35	155	Ball Socket (Nylon) 10mm	Ball Socket (Nylon) 10mm
F4055	7.5	5.34	45	200	Ball Socket (Nylon) 10mm	Ball Socket (Nylon) 10mm
F4056	7.5	5.34	65	289	Ball Socket (Nylon) 10mm	Ball Socket (Nylon) 10mm
F6914	7.5	5.5	82	364	Ball Socket (Nylon) 10mm	Ball Socket (Nylon) 10mm
F7081	8.0	5.75	105.0	467	Blade (10.22mm Dia. Hole)	Blade (10.22mm Dia. Hole)
Group 10 - Replaces Gas Springs with an Extended Length of 8.9" to 10"						
F4677	8.9	6.46	27	120	Ball Socket (Nylon) 10mm	Ball Socket (Nylon) 10mm
D6969	9.6	6.85	70	311	Ball Socket (Nylon) 10mm	Ball Socket (Nylon) 10mm
F6982	9.6	6.85	85	378	Ball Socket (Nylon) 10mm	Ball Socket (Nylon) 10mm
F4036	10.0	6.75	40	177	Blade (10.22mm Dia. Hole)	Blade (10.22mm Dia. Hole)
F4037	10.0	6.75	60	266	Blade (10.22mm Dia. Hole)	Blade (10.22mm Dia. Hole)
F4038	10.0	6.75	80	355	Blade (10.22mm Dia. Hole)	Blade (10.22mm Dia. Hole)
F4039	10.0	6.75	100	444	Blade (10.22mm Dia. Hole)	Blade (10.22mm Dia. Hole)
F4057	10.0	6.6	25	111	Ball Socket (Nylon) 10mm	Ball Socket (Nylon) 10mm
F4058	10.0	6.6	35	155	Ball Socket (Nylon) 10mm	Ball Socket (Nylon) 10mm
F4059	10.0	6.6	50	222	Ball Socket (Nylon) 10mm	Ball Socket (Nylon) 10mm
F4060	10.0	6.6	60	266	Ball Socket (Nylon) 10mm	Ball Socket (Nylon) 10mm
F4061	10.0	6.6	85	378	Ball Socket (Nylon) 10mm	Ball Socket (Nylon) 10mm
F4062	10.0	6.65	120	533	Ball Socket (Nylon) 10mm	Ball Socket (Nylon) 10mm
F4671	10.0	6.75	25	111	Blade (10.22mm Dia. Hole)	Blade (10.22mm Dia. Hole)
F4672	10.0	6.75	51	226	Blade (10.22mm Dia. Hole)	Blade (10.22mm Dia. Hole)
F4673	10.0	6.75	71	315	Blade (10.22mm Dia. Hole)	Blade (10.22mm Dia. Hole)
F4674	10.0	6.75	90	400	Blade (10.22mm Dia. Hole)	Blade (10.22mm Dia. Hole)
F4698	10.0	6.75	110	489	Blade (10.22mm Dia. Hole)	Blade (10.22mm Dia. Hole)
F6348	10.0	7.0	189	840	Ball Socket (Nylon) 10mm	Ball Socket (Nylon) 10mm
F6915	10.0	6.75	45	200	Ball Socket (Nylon) 10mm	Ball Socket (Nylon) 10mm
F6916	10.0	6.75	82	364	Ball Socket (Nylon) 10mm	Ball Socket (Nylon) 10mm
F6984	10.0	7.0	180	800	Ball Socket (Nylon) 10mm	Ball Socket (Nylon) 10mm
Group 11 - Replaces Gas Springs with an Extended Length of 10.5" to 11.5"						
E6917	11.0	7.42	26	115	Ball Socket (Nylon) 10mm	Ball Socket (Nylon) 10mm
E6918	11.0	7.42	35	155	Ball Socket (Nylon) 10mm	Ball Socket (Nylon) 10mm
E6919	11.0	7.42	72	320	Ball Socket (Nylon) 10mm	Ball Socket (Nylon) 10mm
E7083	11.0	7.0	155.0	689	Ball Socket (Nylon) 10mm	Ball Socket (Nylon) 10mm
E7084	11.0	7.0	135.0	600	Ball Socket (Nylon) 10mm	Ball Socket (Nylon) 10mm
F6818	11.25	9.34	35	155	Blade (6mm Dia. Hole)	Blade (6mm Dia. Hole)

Continued on Next Page

UNIVERSAL COVERAGE

COBERTURA UNIVERSAL / COUVERTURE UNIVERSELLE



(A) 10 MM BALL SOCKET
(A) RÓTULA DE 10 MM
(A) DOUILLE SPHÉRIQUE 10 MM



(B) BLADE
(B) CUCHILLA
(B) LAME

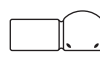

(C) 13 MM BALL SOCKET
(C) RÓTULA DE 13 MM
(C) DOUILLE SPHÉRIQUE 13 MM

Part#	Ext	Comp	Force Pounds	Force Newtons	Shaft Connector	Body Connector
Group 12 - Replaces Gas Springs with an Extended Length of 11.9" to 12.5"						
E6954	11.9	8.15	155	689	Ball Socket (Nylon) 10mm	Ball Socket (Nylon) 10mm
F6970	11.9	8.15	125	556	Ball Socket (Nylon) 10mm	Ball Socket (Nylon) 10mm
E4040	12.0	8.05	40	177	Ball Socket (Nylon) 10mm	Ball Socket (Nylon) 10mm
E4041	12.0	8.05	80	355	Ball Socket (Nylon) 10mm	Ball Socket (Nylon) 10mm
E4042	12.0	8.05	100	444	Ball Socket (Nylon) 10mm	Ball Socket (Nylon) 10mm
E4420	12.0	8.05	30	133	Ball Socket (Nylon) 10mm	Ball Socket (Nylon) 10mm
E4488	12.0	8.05	54	240	Ball Socket (Nylon) 10mm	Ball Socket (Nylon) 10mm
E4511	12.0	8.05	70	311	Ball Socket (Nylon) 10mm	Ball Socket (Nylon) 10mm
E4512	12.0	8.05	90	400	Ball Socket (Nylon) 10mm	Ball Socket (Nylon) 10mm
E4513	12.0	8.05	110	489	Ball Socket (Nylon) 10mm	Ball Socket (Nylon) 10mm
E6920	12.00	7.9	35	155	Ball Socket (Nylon) 10mm	Ball Socket (Nylon) 10mm
E6996	12.5	8.4	40	177	Ball Socket (Nylon) 10mm	Ball Socket (Nylon) 10mm
Group 13 - Replaces Gas Springs with an Extended Length of 12.8" to 13.5"						
E6995	12.8	8.55	35	155	Ball Socket (Nylon) 10mm	Ball Socket (Nylon) 10mm
E4125	13.0	8.4	25	111	Ball Socket (Nylon) 10mm	Ball Socket (Nylon) 10mm
E4126	13.0	8.4	55	244	Ball Socket (Nylon) 10mm	Ball Socket (Nylon) 10mm
E4127	13.0	8.4	65	289	Ball Socket (Nylon) 10mm	Ball Socket (Nylon) 10mm
E4128	13.0	8.4	100	444	Ball Socket (Nylon) 10mm	Ball Socket (Nylon) 10mm
E4129	13.0	8.4	155	689	Ball Socket (Nylon) 10mm	Ball Socket (Nylon) 10mm
E6864	13.0	8.4	30	133	Ball Socket (Nylon) 10mm	Ball Socket (Nylon) 10mm
E6963	13.0	8.5	40	177	Ball Socket (Nylon) 10mm	Ball Socket (Nylon) 10mm
Group 14 - Replaces Gas Springs with an Extended Length of 13.5" to 14.5"						
E6964	14.0	9.0	30	133	Ball Socket (Nylon) 10mm	Ball Socket (Nylon) 10mm
E6985	14.0	9.0	70	311	Ball Socket (Nylon) 10mm	Ball Socket (Nylon) 10mm
E6986	14.0	9.0	138	613	Ball Socket (Nylon) 10mm	Ball Socket (Nylon) 10mm
E4043	14.5	9.25	25	111	Ball Socket (Nylon) 10mm	Ball Socket (Nylon) 10mm
E4044	14.5	9.25	90	400	Ball Socket (Nylon) 10mm	Ball Socket (Nylon) 10mm
E4419	14.5	9.25	35	155	Ball Socket (Nylon) 10mm	Ball Socket (Nylon) 10mm
E4464	14.5	9.25	40	177	Ball Socket (Nylon) 10mm	Ball Socket (Nylon) 10mm
E4517	14.5	9.25	61	271	Ball Socket (Nylon) 10mm	Ball Socket (Nylon) 10mm
E4518	14.5	9.25	100	444	Ball Socket (Nylon) 10mm	Ball Socket (Nylon) 10mm
E4683	14.5	9.25	75	333	Ball Socket (Nylon) 10mm	Ball Socket (Nylon) 10mm
E6981	14.5	9.5	125	556	Ball Socket (Nylon) 10mm	Ball Socket (Nylon) 10mm
Group 15 - Replaces Gas Springs with an Extended Length of 14.5" to 15.5"						
D6967	15.0	9.75	25	111	Blade (10.22mm Dia. Hole)	Blade (10.22mm Dia. Hole)
E6923	15.0	9.4	30	133	Blade (10.22mm Dia. Hole)	Blade (10.22mm Dia. Hole)
E6924	15.0	9.34	26	115	Ball Socket (Nylon) 10mm	Ball Socket (Nylon) 10mm
E6925	15.0	9.34	35	155	Ball Socket (Nylon) 10mm	Ball Socket (Nylon) 10mm
E6926	15.0	9.34	45	200	Ball Socket (Nylon) 10mm	Ball Socket (Nylon) 10mm
E6927	15.0	9.34	65	289	Ball Socket (Nylon) 10mm	Ball Socket (Nylon) 10mm
E6928	15.0	9.38	130	578	Ball Socket (Nylon) 10mm	Ball Socket (Nylon) 10mm
E6971	15.0	9.6	85	378	Ball Socket (Nylon) 10mm	Ball Socket (Nylon) 10mm
E6987	15.0	9.38	150	667	Ball Socket (Nylon) 10mm	Ball Socket (Nylon) 10mm
E6955	15.25	9.75	155	689	Ball Socket (Nylon) 10mm	Ball Socket (Nylon) 10mm
E6972	15.25	9.75	125	556	Ball Socket (Nylon) 10mm	Ball Socket (Nylon) 10mm

Continued on Next Page

UNIVERSAL COVERAGE

COBERTURA UNIVERSAL / COUVERTURE UNIVERSELLE



(A) 10 MM BALL SOCKET
(A) RÓTULA DE 10 MM
(A) DOUILLE SPHÉRIQUE 10 MM



(B) BLADE
(B) CUCHILLA
(B) LAME



(C) 13 MM BALL SOCKET
(C) RÓTULA DE 13 MM
(C) DOUILLE SPHÉRIQUE 13 MM

Part#	Ext	Comp	Force Pounds	Force Newtons	Shaft Connector	Body Connector
Group 16 - Replaces Gas Springs with an Extended Length of 15.9" to 16.5"						
D6949	15.90	10.12	112	498	Ball Socket (Nylon) 10mm	Ball Socket (Nylon) 10mm
D6929	16.0	10.0	65	289	Ball Socket (Nylon) 10mm	Ball Socket (Nylon) 10mm
E6921	16.0	10.0	35	155	Ball Socket (Nylon) 10mm	Ball Socket (Nylon) 10mm
Group 17 - Replaces Gas Springs with an Extended Length of 16.5" to 17.6"						
D6966	17.0	11.0	65	289	Ball Socket (Nylon) 10mm	Ball Socket (Nylon) 10mm
D6973	17.0	11.0	26	115	Ball Socket (Nylon) 10mm	Ball Socket (Nylon) 10mm
D6974	17.0	11.0	155	689	Ball Socket (Nylon) 10mm	Ball Socket (Nylon) 10mm
D6988	17.0	10.75	145	644	Ball Socket (Nylon) 10mm	Ball Socket (Nylon) 10mm
D6989	17.0	10.75	105	467	Ball Socket (Nylon) 10mm	Ball Socket (Nylon) 10mm
E6965	17.0	11.0	95	422	Ball Socket (Nylon) 10mm	Ball Socket (Nylon) 10mm
D4418	17.2	10.6	40	177	Ball Socket (Nylon) 10mm	Ball Socket (Nylon) 10mm
D4482	17.2	10.6	70	311	Ball Socket (Nylon) 10mm	Ball Socket (Nylon) 10mm
D4514	17.2	10.6	55	244	Ball Socket (Nylon) 10mm	Ball Socket (Nylon) 10mm
D4515	17.2	10.6	100	444	Ball Socket (Nylon) 10mm	Ball Socket (Nylon) 10mm
D4516	17.2	10.6	125	556	Ball Socket (Nylon) 10mm	Ball Socket (Nylon) 10mm
D6930	17.2	10.6	145	644	Ball Socket (Nylon) 10mm	Ball Socket (Nylon) 10mm
D6931	17.2	10.6	85	378	Ball Socket (Nylon) 10mm	Ball Socket (Nylon) 10mm
G4318	17.4	10.5	n/a	n/a	Steel Bracket	Steel Bracket
D6950	17.6	10.81	180	800	Blade (8.64mm Dia. Hole)	Blade (8.64mm Dia. Hole)
Group 19 - Replaces Gas Springs with an Extended Length of 18.5" to 19.5"						
D6932	18.5	11.25	30	133	Ball Socket (Nylon) 10mm	Ball Socket (Nylon) 10mm
D6933	18.5	11.25	45	200	Ball Socket (Nylon) 10mm	Ball Socket (Nylon) 10mm
D6934	18.5	11.25	60	266	Ball Socket (Nylon) 10mm	Ball Socket (Nylon) 10mm
D6935	18.5	11.25	75	333	Ball Socket (Nylon) 10mm	Ball Socket (Nylon) 10mm
D6936	18.5	11.25	96	427	Ball Socket (Nylon) 10mm	Ball Socket (Nylon) 10mm
D6937	18.5	11.25	115	511	Ball Socket (Nylon) 10mm	Ball Socket (Nylon) 10mm
D6990	18.5	11.25	40	177	Ball Socket (Nylon) 10mm	Ball Socket (Nylon) 10mm
D6991	18.5	11.25	53	235	Ball Socket (Nylon) 10mm	Ball Socket (Nylon) 10mm
D6992	18.5	11.25	69	306	Ball Socket (Nylon) 10mm	Ball Socket (Nylon) 10mm
D6993	18.5	11.25	105	467	Ball Socket (Nylon) 10mm	Ball Socket (Nylon) 10mm
D6994	18.5	11.25	123	547	Ball Socket (Nylon) 10mm	Ball Socket (Nylon) 10mm
D6948	19.12	11.74	112	498	Ball Socket (Nylon) 10mm	Ball Socket (Nylon) 10mm
G4317	19.30	10.75	n/a	n/a	Steel Bracket	Steel Bracket
Group 20 - Replaces Gas Springs with an Extended Length of 19.5" to 20.5"						
D4247	19.7	11.75	51	226	Ball Socket (Nylon) 10mm	Ball Socket (Nylon) 10mm
D4248	19.7	11.75	65	289	Ball Socket (Nylon) 10mm	Ball Socket (Nylon) 10mm
D4279	19.7	11.75	95	422	Ball Socket (Nylon) 10mm	Ball Socket (Nylon) 10mm
D4280	19.7	11.75	151	671	Ball Socket (Nylon) 10mm	Ball Socket (Nylon) 10mm
D4530	19.7	11.75	120	533	Ball Socket (Nylon) 10mm	Ball Socket (Nylon) 10mm
D6821	19.7	11.8	85	378	Ball Socket (Nylon) 10mm	Ball Socket (Nylon) 10mm
D6938	19.7	11.75	75	333	Ball Socket (Nylon) 10mm	Ball Socket (Nylon) 10mm
D6939	19.7	11.75	105	467	Ball Socket (Nylon) 10mm	Ball Socket (Nylon) 10mm
D6957	20.0	12.0	65	289	Ball Socket (Nylon) 10mm	Ball Socket (Nylon) 10mm
D6958	20.0	12.0	85	378	Ball Socket (Nylon) 10mm	Ball Socket (Nylon) 10mm
D6959	20.0	12.0	95	422	Ball Socket (Nylon) 10mm	Ball Socket (Nylon) 10mm
D6960	20.0	12.0	120	533	Ball Socket (Nylon) 10mm	Ball Socket (Nylon) 10mm

Continued on Next Page

UNIVERSAL COVERAGE

COBERTURA UNIVERSAL / COUVERTURE UNIVERSELLE



(A) 10 MM BALL SOCKET
(A) RÓTULA DE 10 MM
(A) DOUILLE SPHÉRIQUE 10 MM



(B) BLADE
(B) CUCHILLA
(B) LAME

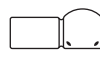

(C) 13 MM BALL SOCKET
(C) RÓTULA DE 13 MM
(C) DOUILLE SPHÉRIQUE 13 MM

Part#	Ext	Comp	Force Pounds	Force Newtons	Shaft Connector	Body Connector
Group 20 - Replaces Gas Springs with an Extended Length of 19.5" to 20.5" (Continued)						
D6961	20.0	12.0	150	667	Ball Socket (Nylon) 10mm	Ball Socket (Nylon) 10mm
D6962	20.0	12.0	45	200	Ball Socket (Nylon) 10mm	Ball Socket (Nylon) 10mm
D6968	20.0	12.0	105	467	Ball Socket (Nylon) 10mm	Ball Socket (Nylon) 10mm
D6975	20.0	12.0	26	115	Ball Socket (Nylon) 10mm	Ball Socket (Nylon) 10mm
D6976	20.0	12.0	35	155	Ball Socket (Nylon) 10mm	Ball Socket (Nylon) 10mm
Group 21 - Replaces Gas Springs with an Extended Length of 20.5" to 21.5"						
D6997	21.0	13.0	65.0	289	Ball Socket (Nylon) 10mm	Ball Socket (Nylon) 10mm
Group 23 - Replaces Gas Springs with an Extended Length of 22.5" to 23.5"						
C6947	23.0	14.0	112	498	Ball Socket (Nylon) 10mm	Ball Socket (Nylon) 10mm
C6977	23.0	14.0	45	200	Ball Socket (Nylon) 10mm	Ball Socket (Nylon) 10mm
E6956	23.0	14.0	75	333	Ball Socket (Nylon) 10mm	Ball Socket (Nylon) 10mm
Group 26 - Replaces Gas Springs with an Extended Length of 25.5" to 26.5"						
C6940	26.0	15.1	60	266	Ball Socket (Nylon) 10mm	Ball Socket (Nylon) 10mm
C6941	26.0	15.1	80	355	Ball Socket (Nylon) 10mm	Ball Socket (Nylon) 10mm
C6978	26.25	15.75	80	355	Ball Socket (Nylon) 10mm	Ball Socket (Nylon) 10mm
C6983	26.25	15.75	90	400	Ball Socket (Nylon) 10mm	Ball Socket (Nylon) 10mm
C4567	26.32	16.08	85	378	Ball Socket (Steel) 13mm	Ball Socket (Steel) 13mm
Group 28 - Replaces Gas Springs with an Extended Length of 27.5" to 28.5"						
B7031	27.5	15.9	40.0	177	Ball Socket (Nylon) 10mm	Ball Socket (Nylon) 10mm
B6942	28.0	16.75	96	427	Ball Socket (Steel) 13mm	Ball Socket (Steel) 13mm
B6943	28.0	16.75	115	511	Ball Socket (Steel) 13mm	Ball Socket (Steel) 13mm
B6944	28.0	16.75	145	644	Ball Socket (Steel) 13mm	Ball Socket (Steel) 13mm
B6980	28.0	16.75	260	1156	Ball Socket (Steel) 13mm	Ball Socket (Steel) 13mm
Group 29 - Replaces Gas Springs with an Extended Length of 28.5" to 29.5"						
B6951	28.62	20.62	184	818	Ball Socket (Nylon) 10mm	Ball Socket (Nylon) 10mm
B4571	28.9	21.67	70	311	Ball Socket (Nylon) 10mm	Captive Ball (Nylon)
B4570	29.05	25.15	114	507	Ball Socket (Nylon) 10mm	Ball Socket (Nylon) 10mm
B6953	29.12	20.37	146	649	Blade (13.04mm Dia. Hole)	Ball Socket (Nylon) 10mm
B4568	29.5	17.5	85	378	Ball Socket (Steel) 13mm	Ball Socket (Steel) 13mm
Group 32 - Replaces Gas Springs with an Extended Length of 31.5" to 32.5"						
A7082	32.5	20.5	85.0	378	Ball Socket (Steel) 13mm	Ball Socket (Steel) 13mm
Group 35 - Replaces Gas Springs with an Extended Length of 34.5" to 35.5"						
A4281	35.25	19.85	84	373	Ball Socket (Nylon) 10mm	Ball Socket (Nylon) 10mm
Hardware Items						
SA3000					10mm Ball Stud Kit	
SA3001					13mm Ball Stud Kit	
SA3002					Shoulder Stud Kit	
SA3100					3 Hole Bracket	
SA3101					2 Hole Bracket	
SA3102					Flush Mount Bracket	

PRODUCT INFORMATION

INFORMACIÓN DEL PRODUCTO / INFORMATIONS PRODUIT



Heavy Gauge Steel Body is electrostatically painted and heat cured to original equipment specification.

El grueso cuerpo de acero se somete a pintado electrostático y tratamiento térmico según especificaciones originales.

La peinture des tubes en acier de fort calibre est appliquée par procédé électrostatique et cuite au four selon les exigences des équipementiers.

Self Cleaning Piston Assembly automatically opens during each compression cycle to keep orifice clear of fluid contaminants and provide smoother operation and more reliable performance.

El pistón de limpieza automática se abre automáticamente durante cada ciclo de compresión, para evitar el ingreso de contaminantes del fluido al orificio y proporcionar una operación más suave y un desempeño más confiable.

Le piston autonettoyant s'ouvre automatiquement à chaque cycle de compression pour garder l'orifice propre et assurer un fonctionnement doux et fiable.

Rubber O-Ring Piston Seal is the most effective type of hydraulic seal – helps prevent fluid leakage around the piston, forcing the fluid to pass efficiently through piston valving components, providing controlled lift and consistent performance.

La junta tórica de caucho del pistón es el tipo más eficaz de sello hidráulico: ayuda a evitar fugas de fluido alrededor del pistón, forzando al fluido a atravesar los componentes de las válvulas del pistón de manera eficiente, proporcionando así una elevación controlada y un desempeño uniforme.

Le joint torique en caoutchouc du piston, qui constitue la méthode d'étanchéité hydraulique la plus efficace, aide à prévenir les fuites autour du piston et force le liquide à traverser ses orifices d'écoulement afin d'offrir une ouverture contrôlée et uniforme.

Unique, Patented Multi-Lobe Seal makes StrongArm® gas springs more tolerant to shaft imperfections, vibration, temperature extremes, and shaft contamination. Precision ground and polished for superior corrosion resistance and leak-free sealing.

El exclusivo sello patentado de lóbulos múltiples hace que los muelles de gas StrongArm® sean más resistentes a las imperfecciones del eje, las vibraciones, las temperaturas extremas y la contaminación del eje. Gracias al esmerilado y pulido de precisión, exhibe una excelente resistencia a la corrosión y un sellado hermético.

Joint multilobé unique breveté rendant les vérins au gaz du StrongArm® plus adaptables aux imperfections de la tige de piston, à la vibration, aux températures extrêmes et à la contamination du piston. Joints d'étanchéité prépolis et polis avec précision pour une résistance supérieure à la corrosion et aux fuites.

Upper Bushing is manufactured with bearing quality precision to provide exact fit with piston rod and promote longer operating life.

El buje superior está fabricado con precisión de calidad tipo cojinete y proporciona un ajuste perfecto con el vástago del pistón, contribuyendo a una vida útil más prolongada.

La bague supérieure est usinée avec une précision comparable à celle d'un roulement, procurant une élévation rigoureusement précise de la tige à piston pour une durée de vie supérieure.

Non-Stick Back-Up Ring enhances performance through improved oil and gas pressure sealing.

El aro de respaldo antiadherente optimiza el desempeño al sellar mejor la presión del aceite y del gas.

L'anneau de sauvegarde antiadhésive améliore les performances grâce à une étanchéité améliorée par pression d'huile et de gaz.

ⓘ CHARGED LIFT SUPPORTS ARE DESIGNED TO BE USED EXCLUSIVELY FOR THE PURPOSE SPECIFIED IN APPLICATION CHARTS. Tech Support 1-888-565-9632

STRONGARM[®] PROGLIDE[™] TAILGATE ASSIST

Tailgates Never Had It So Easy.



10 SKUs covering
34 million domestic
and import VIO



Engineered in US to
OE quality standards
for performance and
durability



1 year limited
warranty



IATF 16949, ISO 9001
certified; passes extensive
quality checks and testing

StrongArm[®] ProGlide[™] Tailgate Assist utilizes a damping strut to safely and slowly lower the tailgate, and keep it gliding down smoothly while controlling the drop rate. It is designed to make tailgate operation smooth and easy. StrongArm[®] ProGlide[™] Tailgate Assist is the ideal upgrade aftermarket accessory for older model pickup trucks and replacement for late model trucks.



- No-drill installation
- Only one needed (for the driver's side of the gate)
- Safely and slowly lowers tailgate
- Longer life for cables and hardware

The **STRONG ARM**[®] Gas Charged Lift Supports are intended for use **ONLY** in motor vehicles as set forth in this application guide. USE IN ANY OTHER APPLICATION IS IMPROPER AND MAY LEAD TO MALFUNCTIONS OR SERIOUS PERSONAL INJURIES. With respect to any application other than those set forth herein, Strongarm, LLC. MAKES NO EXPRESS OR IMPLIED WARRANTIES OF ANY KIND, INCLUDING ANY WARRANTIES OF MERCHANTABILITY OR FITNESS FOR A PARTICULAR PURPOSE.

When used in accordance with the foregoing Application Guide, Strongarm, LLC. warrants the **STRONG ARM**[®] Gas Charged Lift Supports against any defects in manufacturing or workmanship for a period of one year from installation. This limited warranty does not apply to: (1) any product altered or subjected to abuse, neglect, or accident, or (2) any product that is improperly installed. To make a claim under this limited warranty, return the product to the Strongarm, LLC. supplier from whom it was purchased for certification and replacement. **Strongarm, LLC.'s SOLE OBLIGATION UNDER THIS LIMITED WARRANTY IS REPLACEMENT OF THE DEFECTIVE PRODUCT; COSTS OF REMOVAL AND INSTALLATION ARE NOT INCLUDED. Strongarm, LLC. SHALL NOT BE LIABLE FOR INCIDENTAL OR CONSEQUENTIAL DAMAGES. THESE LIMITATIONS ON LIABILITY SHALL BE APPLICABLE TO ANY CLAIMS PRESENTED TO Strongarm, LLC., REGARDLESS OF THE LEGAL THEORY FORMING THE BASIS OF SUCH CLAIM, AND WHETHER SUCH THEORY INVOLVES NEGLIGENCE, CONTRACTUAL LIABILITY, OR OTHERWISE.** Except as set forth above, **Strongarm, LLC. DISCLAIMS ANY AND ALL EXPRESS WARRANTIES, ALL IMPLIED WARRANTIES, INCLUDING ANY WARRANTY OF MERCHANTABILITY OR FITNESS FOR A PARTICULAR PURPOSE, ARE LIMITED IN DURATION TO ONE YEAR FROM INSTALLATION.**

Some states do not allow limitations on how long an implied warranty lasts, so the above limitation may not apply to you. Some states do not allow the exclusion or limitation of incidental or consequential damages, so the above limitation or exclusion may not apply to you. This limited warranty gives you specific legal rights, and you may also have other rights which vary from state to state.

Les supports éleveurs à gaz **STRONG ARM**[®] sont destinés **UNIQUEMENT** aux applications automobiles tel qu'indiqué dans ce guide. TOUTE UTILISATION AUTRE QUE CELLES MENTIONNÉES N'EST PAS PERMISE ET POURRAIT ENGENDRER UNE ANOMALIE DE FONCTIONNEMENT ET DE GRAVES BLESSURES. Pour toute application qui n'est pas indiquée dans ce Guide, AMV N'ACCORDE AUCUNE GARANTIE EXPLICITE OU IMPLICITE, OU TOUTE AUTRE GARANTIE DE QUALITÉ MARCHANDE OU ADAPTABLE À UN USAGE PARTICULIER.

Lorsqu'ils sont utilisés conformément aux applications précitées dans ce Guide, Strongarm, LLC. garantit les supports éleveurs à gaz **STRONG ARM**[®] contre tous défauts de fabrication et de main-d'œuvre pour une période d'un an à compter de la date d'installation. Cette garantie limitée ne s'applique pas : (1) à tout produit modifié ou soumis à un usage abusif, à des négligences ou à des accidents, ou (2) à tout produit incorrectement installé. Pour toute réclamation en vertu de la présente garantie limitée, le produit doit être retourné au détaillant ayant vendu le produit à l'origine pour la vérification et le remplacement du produit. **L'OBLIGATION DE Strongarm, LLC. SE LIMITE AU REMPLACEMENT DU PRODUIT DÉFECTUEUX; LES COÛTS DE DÉMONTAGE ET D'INSTALLATION NE SONT PAS INCLUS. Strongarm, LLC. NE SERA PAS TENUE RESPONSABLE DE TOUT DOMMAGE DIRECT ET CONSÉCUTIF. CES LIMITATIONS DE RESPONSABILITÉ S'APPLIQUENT À TOUTES LES RÉCLAMATIONS PRÉSENTÉES À Strongarm, LLC., SANS ÉGARD À LA THÉORIE JURIDIQUE À LA BASE DE LA RÉCLAMATION, PEU IMPORTE QUE CETTE THÉORIE COMPRENNE UNE RESPONSABILITÉ CONTRACTUELLE POUR NÉGLIGENCE, OU AUTREMENT.** Sauf les clauses définies ci-dessus, **Strongarm, LLC. REJETTE TOUTES GARANTIES IMPLICITES OU EXPLICITES, INCLUANT LES GARANTIES DE QUALITÉ MARCHANDE ET DE COMPATIBILITÉ À UN USAGE SPÉCIFIQUE, LA GARANTIE EST LIMITÉE À UN AN SUIVANT L'INSTALLATION.**

Dans certains États et provinces, les limitations afférentes à la durée d'une garantie implicite ne sont pas permises et, ainsi, il se peut que les limitations précitées ne s'appliquent pas à vous. Dans certains États et provinces, l'exclusion et les limitations afférentes aux dommages accessoires et indirects ne sont pas permises et, ainsi, il se peut que les limitations précitées ne s'appliquent pas à vous. La présente garantie vous donne des droits spécifiques, et il se peut que vous ayez d'autres droits qui varient selon les États et les provinces.

Los soportes elevadores de gas **STRONG ARM**[®] están diseñados para usarse **SOLAMENTE** en vehículos automotores según lo estipulado en esta guía de aplicaciones. EL USO EN CUALQUIER OTRA APLICACIÓN ES INCORRECTO Y PUEDE OCASIONAR FALLAS O LESIONES FÍSICAS GRAVES. Con respecto a cualquier otra aplicación distinta de las aquí establecidas, Strongarm, LLC. NO OTORGA NINGÚN TIPO DE GARANTÍA, NI EXPLÍCITA NI IMPLÍCITA, INCLUYENDO TODA GARANTÍA DE COMERCIALIZACIÓN O DE APTITUD PARA UN USO DETERMINADO.

Siempre y cuando la utilización se realice de acuerdo con la Guía de Aplicaciones anterior, Strongarm, LLC. garantiza los soportes elevadores de gas **STRONG ARM**[®] contra cualquier defecto de fabricación o mano de obra durante un período de un año a partir de la fecha de instalación. Esta garantía limitada no rige para: (1) cualquier producto que haya sido alterado o que haya sido objeto de abuso, negligencia o accidente, o (2) cualquier producto que no se haya instalado correctamente. Para presentar un reclamo bajo esta garantía limitada, devuelva el producto al proveedor Strongarm, LLC. donde fue adquirido para iniciar el proceso de certificación y reemplazo. **LA ÚNICA OBLIGACIÓN DE Strongarm, LLC. BAJO ESTA GARANTÍA LIMITADA ES EL REEMPLAZO DEL PRODUCTO DEFECTUOSO; LOS COSTOS DE DESINSTALACIÓN E INSTALACIÓN NO ESTÁN INCLUIDOS. Strongarm, LLC. NO ASUME NINGUNA RESPONSABILIDAD POR DAÑOS INDIRECTOS O EMERGENTES. ESTAS LIMITACIONES DE RESPONSABILIDAD RIGEN TODO RECLAMO PRESENTADO ANTE Strongarm, LLC., INDEPENDIENTEMENTE DE LA DOCTRINA JURÍDICA QUE SUSTENTE TAL RECLAMO, Y DE SI DICHA DOCTRINA INCLUYE O NO NEGLIGENCIA, RESPONSABILIDAD CONTRACTUAL O CUALQUIER OTRO ARGUMENTO.** Con excepción de lo arriba establecido, **Strongarm, LLC. NO ASUME RESPONSABILIDAD ALGUNA POR NINGUNA GARANTÍA EXPLÍCITA E IMPLÍCITA, INCLUYENDO TODA GARANTÍA DE COMERCIALIZACIÓN O APTITUD PARA UN FIN DETERMINADO. TODA GARANTÍA ESTÁ LIMITADA EN DURACIÓN A UN AÑO A PARTIR DE LA FECHA DE INSTALACIÓN.**

Algunos estados no permiten limitaciones de la duración de las garantías implícitas, así que la limitación anterior puede no ser válida en su caso. Algunos estados no permiten la exclusión o limitación de daños indirectos o emergentes, así que la limitación anterior puede no ser válida en su caso. Esta garantía limitada le confiere derechos legales específicos, y es posible que tenga otros derechos, los cuales pueden variar entre un estado y otro.

Tech Support: (888) 565-9632

GAS CHARGED LIFT SUPPORTS ARE DESIGNED TO BE USED EXCLUSIVELY FOR THE PURPOSES SPECIFIED IN THE APPLICATION CHARTS.



Tech Support: **(888) 565-9632**

[StrongArmLiftSupports.com](https://www.StrongArmLiftSupports.com)